



ROVALI

PEÇAS PARA TRUCKS E CARRETAS



Catálogo 2021



PRODUTOS COMPATÍVEIS COM:

<i>Linha Randon</i> _____	04	<i>Para-Lamas</i> _____	122
<i>Linha Guerra</i> _____	28	<i>Suportes de Para-Lamas</i> _____	123
<i>Linha Librelato</i> _____	49	<i>Suportes de Placas</i> _____	125
<i>Linha Facchini</i> _____	68	<i>Suportes de Sinaleiras</i> _____	126
<i>Linha Noma</i> _____	74	<i>Suportes Fixação Pé Mecânico</i> _____	128
<i>Linha Schiffer</i> _____	95	<i>Conexões Elétricas Pneumáticas</i> _____	129
<i>Tombadores</i> _____	98	<i>Linha Caçamba</i> _____	130
<i>Travessas Passantes</i> _____	100	<i>Presilhas e Travas de Estepe</i> _____	134
<i>Bocas de Graneleira</i> _____	102	<i>Diversos</i> _____	135
<i>Arcos de Graneleira</i> _____	103	<i>Linha Scania</i> _____	140
<i>Catracas</i> _____	104	<i>Linha Volvo</i> _____	141
<i>Para-Choques</i> _____	106	<i>Tampas Plásticas</i> _____	142
<i>Placa Sinaliz. Veículo Longo</i> _____	112	<i>Cintas e Redes de Contenção</i> _____	148
<i>Protetores de Ciclista</i> _____	113	<i>Placas Refletivas</i> _____	149
<i>Tira-Fino</i> _____	115	<i>Faixas Refletivas</i> _____	150
<i>Mesas Pino Rei</i> _____	116	<i>Sider Facchini</i> _____	152
<i>Separador Rodas/Pinos Forquilha</i> _____	117	<i>Sider Librelato</i> _____	162
<i>Arruelas</i> _____	118	<i>Sider Randon</i> _____	172
<i>Caixas de Ferramentas</i> _____	119	<i>Componentes p/Sider</i> _____	183
<i>Suportes de Caixas de Ferram.</i> _____	120		
<i>Kit Amarração</i> _____	121		

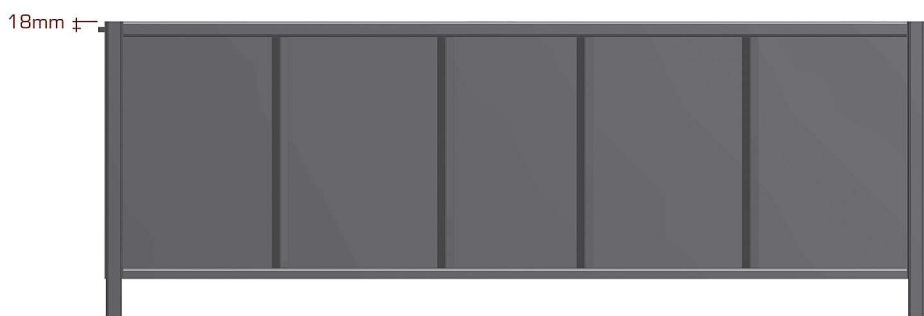

FRONTAIS - BATENTE ANTIGO / MODELO 2008

R-101

 Frontal de Graneleira Inferior
 Batente Antigo

COD.	MEDIDAS
R-101-A	550 mm
R-101-B	600 mm
R-101-C	650 mm
R-101-D	700 mm
R-101-E	800 mm
R-101-F	1000 mm
R-101-G	1100 mm

R-231

 Frontal de Graneleira Inferior
 Modelo 2008

COD.	MEDIDAS
R-231-A	550 mm
R-231-B	600 mm
R-231-C	650 mm
R-231-D	700 mm
R-231-E	800 mm
R-231-F	1000 mm
R-231-G	1100 mm

R-102

 Frontal de Graneleira Superior
 Batente Antigo

COD.	MEDIDAS
R-102-A	550 mm
R-102-B	600 mm
R-102-C	650 mm
R-102-D	700 mm
R-102-E	800 mm
R-102-F	1000 mm
R-102-G	1100 mm

R-232

 Frontal de Graneleira Superior
 Modelo 2008

COD.	MEDIDAS
R-232-A	550 mm
R-232-B	600 mm
R-232-C	650 mm
R-232-D	700 mm
R-232-E	800 mm
R-232-F	1000 mm
R-232-G	1100 mm

FRONTAIS - BATENTE ANTIGO / MODELO 2008

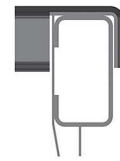
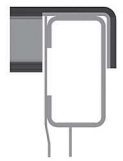
R-103
 Batente Antigo

R-233
 Modelo 2008

R-103

 Frontal de Granelreira Fominha
 Batente Antigo

COD.	MEDIDAS
R-103-A	300 mm
R-103-B	400 mm

R-233

 Frontal de Granelreira Fominha
 Modelo 2008

COD.	MEDIDAS
R-233-A	300 mm
R-233-B	400 mm

FUEIROS - FOMINHA

BATENTE ANTIGO / 95mm

MODELO 2008 / 95mm

MODELO LARGO / 145mm

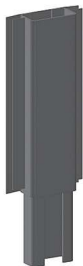
R-107

Fueiro Lateral Fominha

COD.	MEDIDAS
R-107-A	300 mm
R-107-B	400 mm

R-117

Fueiro Lateral Fominha

COD.	MEDIDAS
R-117-A	300 mm
R-117-B	400 mm

R-122

Fueiro Lateral Fominha

COD.	MEDIDAS
R-122-A	300 mm
R-122-B	400 mm

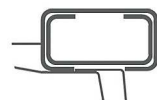
R-112

Fueiro Canto Fominha Dir.

COD.	MEDIDAS
R-112-A	300 mm
R-112-B	400 mm

R-118

Fueiro Canto Fominha Dir.

COD.	MEDIDAS
R-118-A	300 mm
R-118-B	400 mm

R-127

Fueiro Canto Fominha Dir.

COD.	MEDIDAS
R-127-A	300 mm
R-127-B	400 mm

R-113

Fueiro Canto Fominha Esq.

COD.	MEDIDAS
R-113-A	300 mm
R-113-B	400 mm

R-119

Fueiro Canto Fominha Esq.

COD.	MEDIDAS
R-119-A	300 mm
R-119-B	400 mm

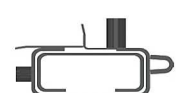
R-128

Fueiro Canto Fominha Esq.

COD.	MEDIDAS
R-128-A	300 mm
R-128-B	400 mm

FUEIROS - BATENTE ANTIGO / largura 95mm

R-105

Fueiro Lateral Inferior

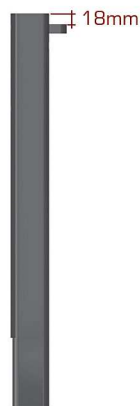

COD.	MEDIDAS
R-105-A	550 mm
R-105-B	600 mm
R-105-C	650 mm
R-105-D	700 mm
R-105-E	800 mm
R-105-F	1000 mm
R-105-G	1100 mm

R-106

Fueiro Lateral Superior

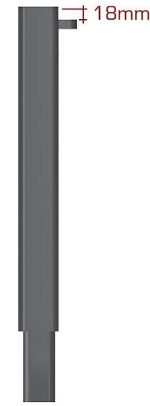

COD.	MEDIDAS
R-106-A	550 mm
R-106-B	600 mm
R-106-C	650 mm
R-106-D	700 mm
R-106-E	800 mm
R-106-F	1000 mm
R-106-G	1100 mm

R-108

Fueiro Canto Inferior Direito

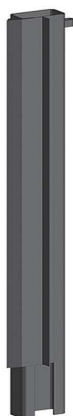

COD.	MEDIDAS
R-108-A	550 mm
R-108-B	600 mm
R-108-C	650 mm
R-108-D	700 mm
R-108-E	800 mm
R-108-F	1000 mm
R-108-G	1100 mm

R-109

Fueiro Canto Inferior Esquerdo

COD.	MEDIDAS
R-109-A	550 mm
R-109-B	600 mm
R-109-C	650 mm
R-109-D	700 mm
R-109-E	800 mm
R-109-F	1000 mm
R-109-G	1100 mm

R-110

Fueiro Canto Superior Direito



COD.	MEDIDAS
R-110-A	550 mm
R-110-B	600 mm
R-110-C	650 mm
R-110-D	700 mm
R-110-E	800 mm
R-110-F	1000 mm
R-110-G	1100 mm

R-111

Fueiro Canto Superior Esquerdo

COD.	MEDIDAS
R-111-A	550 mm
R-111-B	600 mm
R-111-C	650 mm
R-111-D	700 mm
R-111-E	800 mm
R-111-F	1000 mm
R-111-G	1100 mm

FUEIROS - MODELO 2008 / largura 95mm

18mm

R-222

Fueiro Lateral Inferior

COD.	MEDIDAS
R-222-A	550 mm
R-222-B	600 mm
R-222-C	650 mm
R-222-D	700 mm
R-222-E	800 mm
R-222-F	1000 mm
R-222-G	1100 mm



81mm

R-223

Fueiro Lateral Superior

COD.	MEDIDAS
R-223-A	550 mm
R-223-B	600 mm
R-223-C	650 mm
R-223-D	700 mm
R-223-E	800 mm
R-223-F	1000 mm
R-223-G	1100 mm

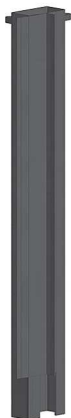
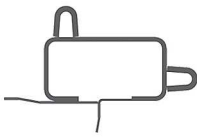
R-224

Fueiro Canto Inferior Direito

COD.	MEDIDAS
R-224-A	550 mm
R-224-B	600 mm
R-224-C	650 mm
R-224-D	700 mm
R-224-E	800 mm
R-224-F	1000 mm
R-224-G	1100 mm

R-225

Fueiro Canto Inferior Esquerdo

COD.	MEDIDAS
R-225-A	550 mm
R-225-B	600 mm
R-225-C	650 mm
R-225-D	700 mm
R-225-E	800 mm
R-225-F	1000 mm
R-225-G	1100 mm

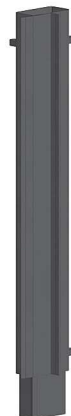
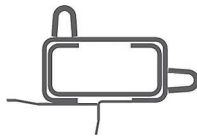
R-226

Fueiro Canto Superior Direito

COD.	MEDIDAS
R-226-A	550 mm
R-226-B	600 mm
R-226-C	650 mm
R-226-D	700 mm
R-226-E	800 mm
R-226-F	1000 mm
R-226-G	1100 mm

R-227

Fueiro Canto Superior Esquerdo

COD.	MEDIDAS
R-227-A	550 mm
R-227-B	600 mm
R-227-C	650 mm
R-227-D	700 mm
R-227-E	800 mm
R-227-F	1000 mm
R-227-G	1100 mm

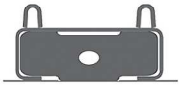
FUEIROS - MODELO LARGO / largura 145mm

R-120

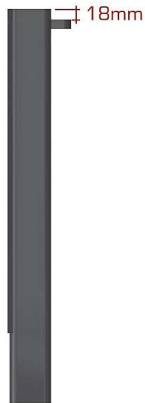
Fueiro Lateral Inferior

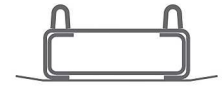

COD.	MEDIDAS
R-120-A	550 mm
R-120-B	600 mm
R-120-C	650 mm
R-120-D	700 mm
R-120-E	800 mm
R-120-F	1000 mm
R-120-G	1100 mm

R-121

Fueiro Lateral Superior

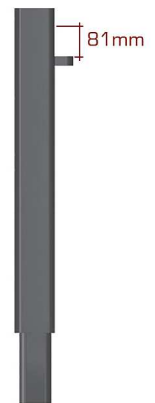

COD.	MEDIDAS
R-121-A	550 mm
R-121-B	600 mm
R-121-C	650 mm
R-121-D	700 mm
R-121-E	800 mm
R-121-F	1000 mm
R-121-G	1100 mm

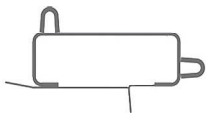
R-123

Fueiro Canto Inferior Direito

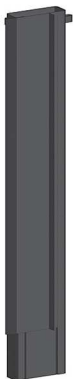

COD.	MEDIDAS
R-123-A	550 mm
R-123-B	600 mm
R-123-C	650 mm
R-123-D	700 mm
R-123-E	800 mm
R-123-F	1000 mm
R-123-G	1100 mm

R-124

Fueiro Canto Inferior Esquerdo

COD.	MEDIDAS
R-124-A	550 mm
R-124-B	600 mm
R-124-C	650 mm
R-124-D	700 mm
R-124-E	800 mm
R-124-F	1000 mm
R-124-G	1100 mm

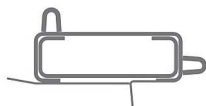
R-125

Fueiro Canto Superior Direito

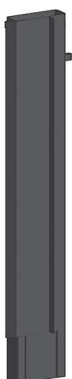

COD.	MEDIDAS
R-125-A	550 mm
R-125-B	600 mm
R-125-C	650 mm
R-125-D	700 mm
R-125-E	800 mm
R-125-F	1000 mm
R-125-G	1100 mm

R-126

Fueiro Canto Superior Esquerdo

COD.	MEDIDAS
R-126-A	550 mm
R-126-B	600 mm
R-126-C	650 mm
R-126-D	700 mm
R-126-E	800 mm
R-126-F	1000 mm
R-126-G	1100 mm

FUEIROS - CARGA SECA / largura 95mm

* Compatíveis somente com ferragem cód.R-281

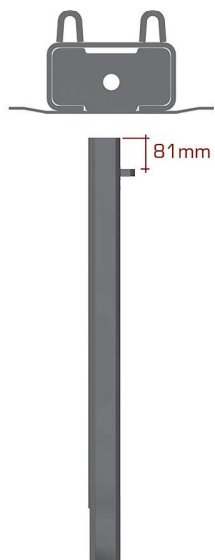
R-241

Fueiro Lateral Carga Seca - Mod.2008

COD.	MEDIDAS
R-241-A	550 mm
R-241-B	600 mm
R-241-C	650 mm
R-241-D	700 mm
R-241-E	800 mm
R-241-F	1000 mm
R-241-G	1100 mm

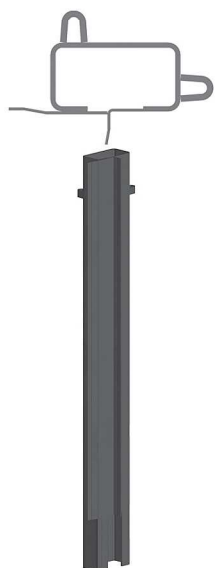
R-242

Fueiro Canto Direito Carga Seca - Mod.2008

COD.	MEDIDAS
R-242-A	550 mm
R-242-B	600 mm
R-242-C	650 mm
R-242-D	700 mm
R-242-E	800 mm
R-242-F	1000 mm
R-242-G	1100 mm

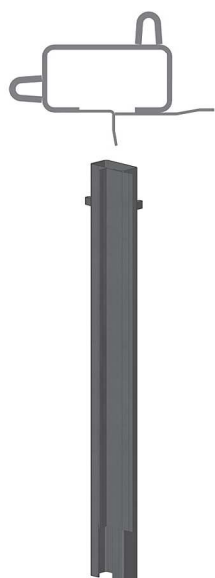
R-243

Fueiro Canto Esquerdo Carga Seca - Mod.2008

COD.	MEDIDAS
R-243-A	550 mm
R-243-B	600 mm
R-243-C	650 mm
R-243-D	700 mm
R-243-E	800 mm
R-243-F	1000 mm
R-243-G	1100 mm

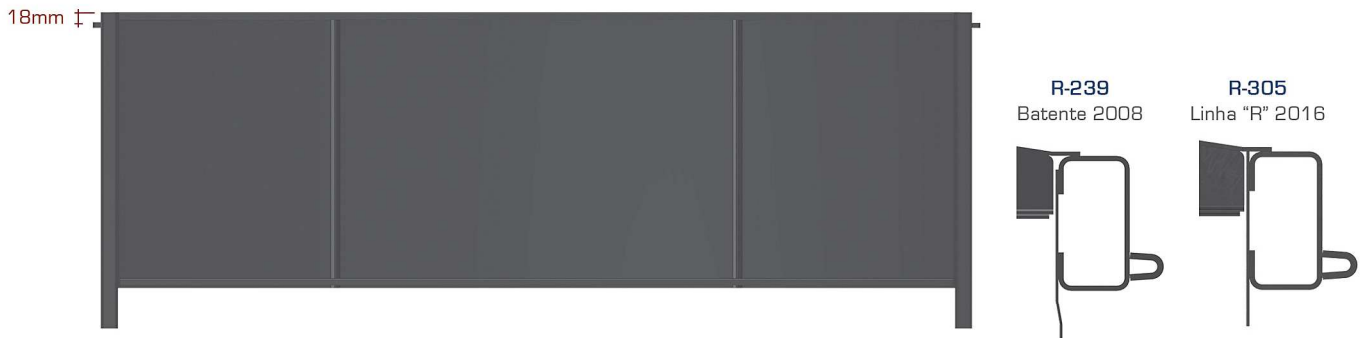
FRONTAIS - BATENTE MOD.2008 / LINHA "R" 2016

R-239

 Frontal de Graneleira Inferior
 Batente Mod.2008

COD.	MEDIDAS
R-239-A	550 mm
R-239-B	600 mm
R-239-C	650 mm
R-239-D	700 mm
R-239-E	800 mm
R-239-F	1000 mm

R-305

 Frontal de Graneleira Inferior
 Linha "R" 2016

COD.	MEDIDAS
R-305-A	550 mm
R-305-B	600 mm
R-305-C	650 mm
R-305-D	700 mm
R-305-E	800 mm
R-305-F	1000 mm

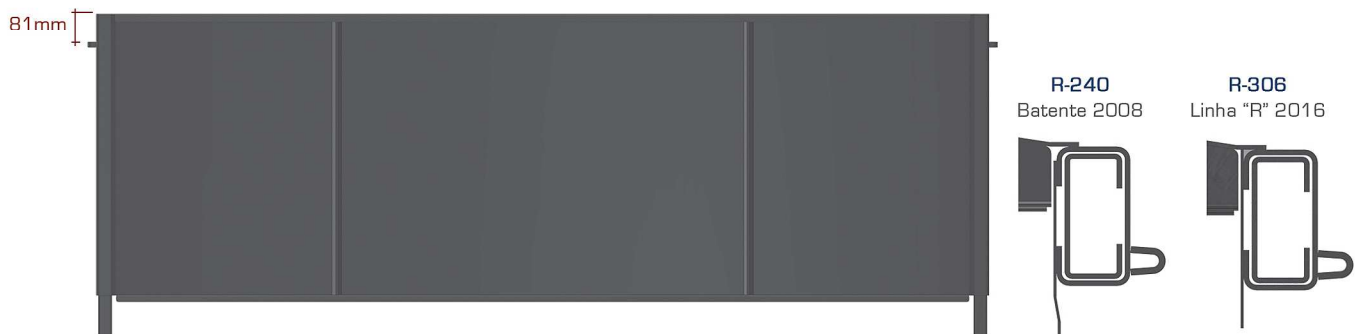
R-240

 Frontal de Graneleira Superior
 Batente Mod.2008

COD.	MEDIDAS
R-240-A	550 mm
R-240-B	600 mm
R-240-C	650 mm
R-240-D	700 mm
R-240-E	800 mm
R-240-F	1000 mm

R-306

 Frontal de Graneleira Superior
 Linha "R" 2016

COD.	MEDIDAS
R-306-A	550 mm
R-306-B	600 mm
R-306-C	650 mm
R-306-D	700 mm
R-306-E	800 mm
R-306-F	1000 mm

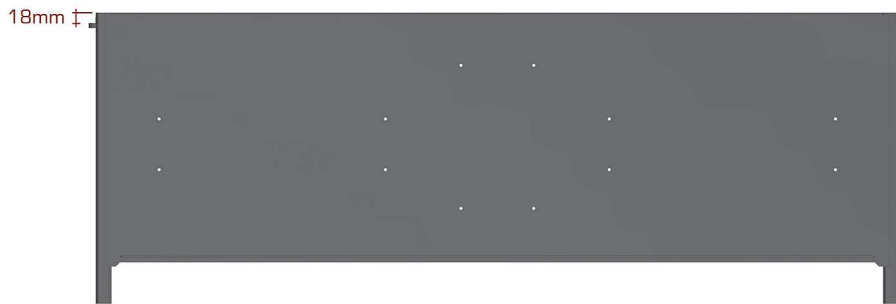

R-387
Linha 70 Anos

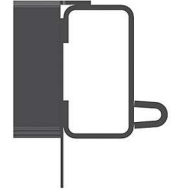

R-387

Frontal Inferior Mod. Randon 70 anos

COD.	MEDIDAS
R-387-A	550 mm
R-387-B	600 mm
R-387-C	650 mm
R-387-D	700 mm
R-387-E	800 mm
R-387-F	1000 mm



R-388
Linha 70 Anos

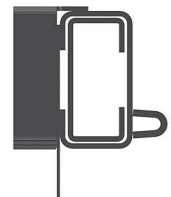

R-388

Frontal Superior Mod. Randon 70 anos

COD.	MEDIDAS
R-388-A	550 mm
R-388-B	600 mm
R-388-C	650 mm
R-388-D	700 mm
R-388-E	800 mm
R-388-F	1000 mm

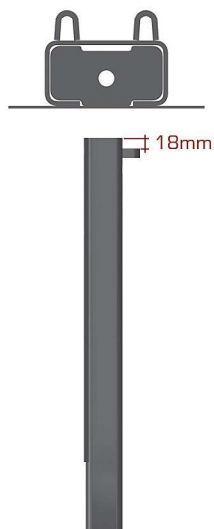
FUEIROS - LINHA "R" 2016 / largura 95mm

R-307

Fuego Lateral Inferior

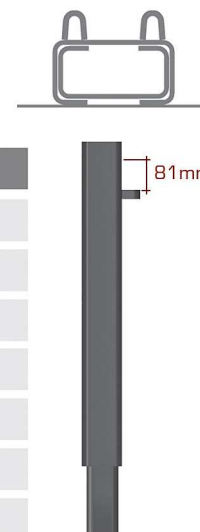
COD.	MEDIDAS
R-307-A	550 mm
R-307-B	600 mm
R-307-C	650 mm
R-307-D	700 mm
R-307-E	800 mm
R-307-F	1000 mm
R-307-G	1100 mm

R-308

Fuego Lateral Superior

COD.	MEDIDAS
R-308-A	550 mm
R-308-B	600 mm
R-308-C	650 mm
R-308-D	700 mm
R-308-E	800 mm
R-308-F	1000 mm
R-308-G	1100 mm

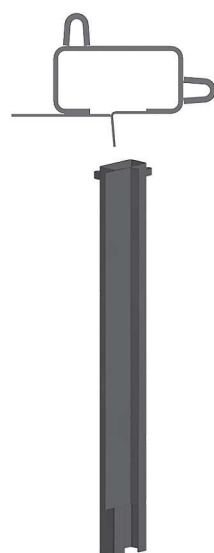
R-309

Fuego Canto Inferior Direito

COD.	MEDIDAS
R-309-A	550 mm
R-309-B	600 mm
R-309-C	650 mm
R-309-D	700 mm
R-309-E	800 mm
R-309-F	1000 mm
R-309-G	1100 mm

R-310

Fuego Canto Inferior Esquerdo

COD.	MEDIDAS
R-310-A	550 mm
R-310-B	600 mm
R-310-C	650 mm
R-310-D	700 mm
R-310-E	800 mm
R-310-F	1000 mm
R-310-G	1100 mm

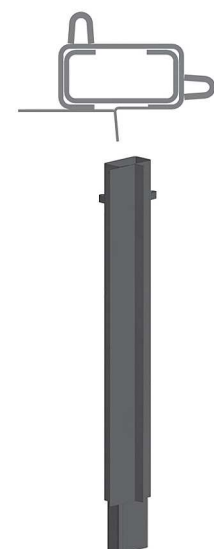
R-311

Fuego Canto Superior Direito

COD.	MEDIDAS
R-311-A	550 mm
R-311-B	600 mm
R-311-C	650 mm
R-311-D	700 mm
R-311-E	800 mm
R-311-F	1000 mm
R-311-G	1100 mm

R-312

Fuego Canto Superior Esquerdo

COD.	MEDIDAS
R-312-A	550 mm
R-312-B	600 mm
R-312-C	650 mm
R-312-D	700 mm
R-312-E	800 mm
R-312-F	1000 mm
R-312-G	1100 mm

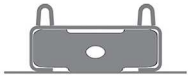
FUEIROS - LINHA "R" 2016 / MOD. LARGO / largura 145mm

R-315

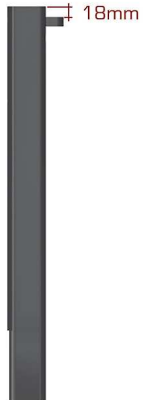
Fueiro Lateral Inferior

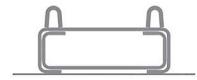

COD.	MEDIDAS
R-315-A	550 mm
R-315-B	600 mm
R-315-C	650 mm
R-315-D	700 mm
R-315-E	800 mm
R-315-F	1000 mm
R-315-G	1100 mm

R-316

Fueiro Lateral Superior

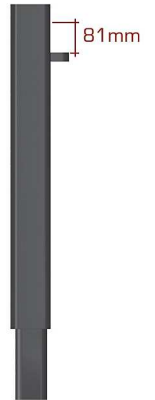

COD.	MEDIDAS
R-316-A	550 mm
R-316-B	600 mm
R-316-C	650 mm
R-316-D	700 mm
R-316-E	800 mm
R-316-F	1000 mm
R-316-G	1100 mm

R-317

Fueiro Canto Inferior Direito



COD.	MEDIDAS
R-317-A	550 mm
R-317-B	600 mm
R-317-C	650 mm
R-317-D	700 mm
R-317-E	800 mm
R-317-F	1000 mm
R-317-G	1100 mm

R-318

Fueiro Canto Inferior Esquerdo

COD.	MEDIDAS
R-318-A	550 mm
R-318-B	600 mm
R-318-C	650 mm
R-318-D	700 mm
R-318-E	800 mm
R-318-F	1000 mm
R-318-G	1100 mm

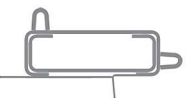
R-319

Fueiro Canto Superior Direito



COD.	MEDIDAS
R-319-A	550 mm
R-319-B	600 mm
R-319-C	650 mm
R-319-D	700 mm
R-319-E	800 mm
R-319-F	1000 mm
R-319-G	1100 mm

R-320

Fueiro Canto Superior Esquerdo

COD.	MEDIDAS
R-320-A	550 mm
R-320-B	600 mm
R-320-C	650 mm
R-320-D	700 mm
R-320-E	800 mm
R-320-F	1000 mm
R-320-G	1100 mm

R-161

Perfil Dianteiro 2420mm

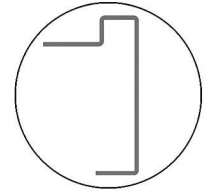

R-161-A

Perfil Dianteiro para Freio ABS

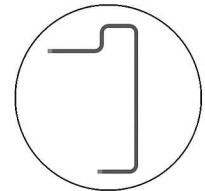

R-161-B

Perfil Dianteiro Assoalho de Ferro



R-161-C

Perfil Dianteiro Assoalho de Ferro ABS

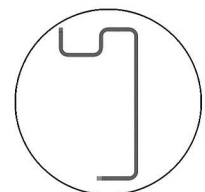

R-160-A

Perfil Traseiro 2430mm (chapa 4,25mm)

R-160-B

Perfil Traseiro 2430mm (chapa 6,35mm)

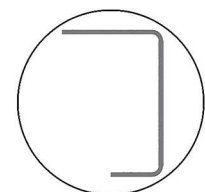

R-160-C

Perfil Traseiro Linha R 2423mm

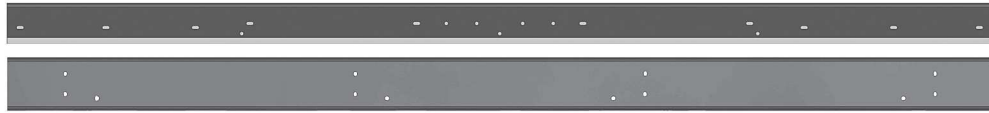

Vista da furação inferior

Vista da furação frontal

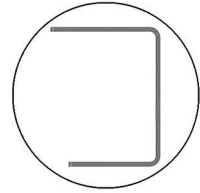

R-160-D

Perfil Traseiro para Assoalho de Ferro s/furação (4,25mm)

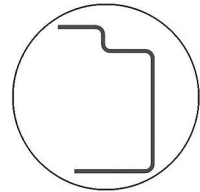

R-160-E

Perfil Traseiro Mod.2018 (4,25mm)

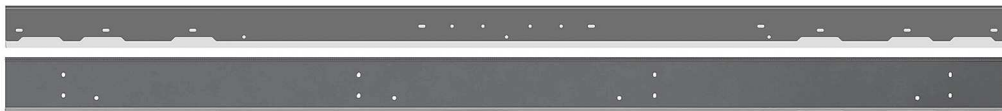

Vista da furação inferior

Vista da furação frontal

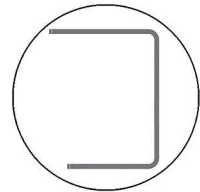

R-160-F

Perfil Traseiro Mod.2018 (6,35mm)

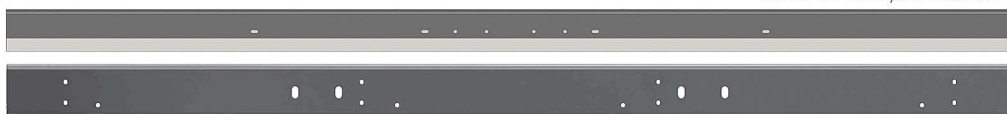

Vista da furação inferior

Vista da furação frontal

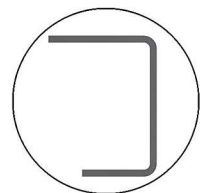

R-184

Perfil Lateral Assoalho de Ferro s/furação

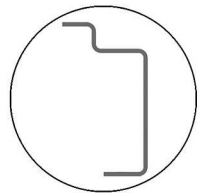

COD.	MEDIDAS
R-184-A	2230 mm
R-184-B	2330 mm
R-184-C	2430 mm
R-184-D	2960 mm

LATERAIS DE CARRETA / EMENDAS DE ASSOALHO
R-159

Lateral da Carreta com Furação

Vista da furação inferior

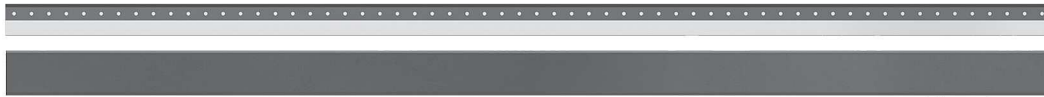

Vista frontal

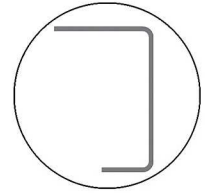

COD.	MEDIDAS	COD.	MEDIDAS
R-159-A	2230 mm	R-159-C	2430 mm
R-159-B	2330 mm	R-159-D	2970 mm

R-402

Lateral da Carreta com Furação de "G"

Vista da furação inferior



Vista da furação frontal

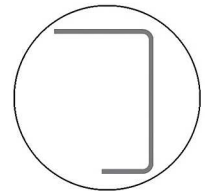

COD.	MEDIDAS	COD.	MEDIDAS
R-402-A	2230 mm	R-402-C	2430 mm
R-402-B	2330 mm	R-402-D	2970 mm

R-235

Emenda do Assoalho

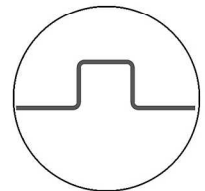

COD.	MEDIDAS
R-235-A	2440 mm (18 mm)
R-235-B	2440 mm (20 mm)
R-235-C	2440 mm (22 mm)

R-202

Cantoneira do Assoalho

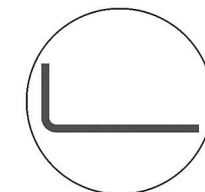

COD.	MEDIDAS
R-202-A	3000 mm (chapa 2 mm)
R-202-B	3000 mm (chapa 3 mm)

R-280

Ferragem Tampa Lateral Inferior

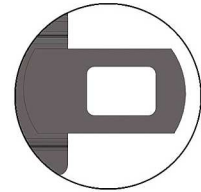
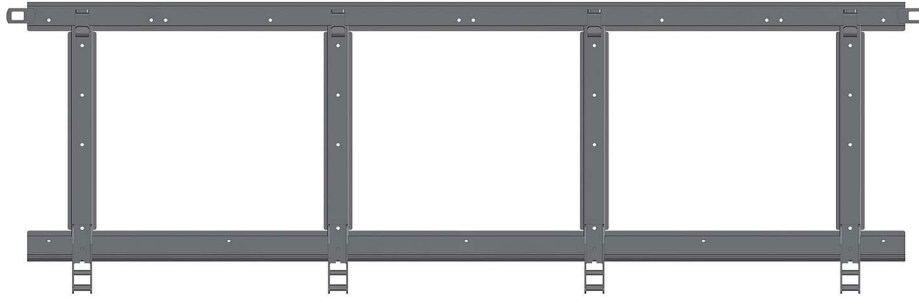
 Fueiro compatível:
 Altura da Presilha 18mm

COD.	MEDIDAS	COD.	MEDIDAS	COD.	MEDIDAS	COD.	MEDIDAS
R-280-A	550 x 2220mm	R-280-H	600 x 2960mm	R-280-O	700 x 2420mm	R-280-V	1000 x 2320mm
R-280-B	550 x 2320mm	R-280-I	650 x 2220mm	R-280-P	700 x 2960mm	R-280-W	1000 x 2420mm
R-280-C	550 x 2420mm	R-280-J	650 x 2320mm	R-280-Q	800 x 2220mm	R-280-X	1000 x 2960mm
R-280-D	550 x 2960mm	R-280-K	650 x 2420mm	R-280-R	800 x 2320mm	R-280-Y	1100 x 2220mm
R-280-E	600 x 2220mm	R-280-L	650 x 2960mm	R-280-S	800 x 2420mm	R-280-Z	1100 x 2320mm
R-280-F	600 x 2320mm	R-280-M	700 x 2220mm	R-280-T	800 x 2960mm	R-280-AA	1100 x 2420mm
R-280-G	600 x 2420mm	R-280-N	700 x 2320mm	R-280-U	1000 x 2220mm	R-280-AB	1100 x 2960mm

R-281

Ferragem Tampa Lateral Superior - Carreta com 2 Tampas

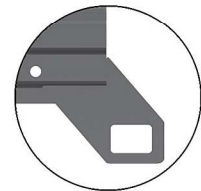
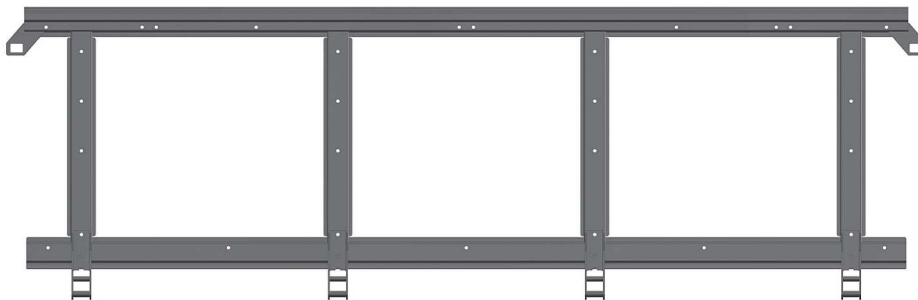
 Fueiro compatível:
 Altura da Presilha 81mm

COD.	MEDIDAS	COD.	MEDIDAS	COD.	MEDIDAS	COD.	MEDIDAS
R-281-A	550 x 2230mm	R-281-H	600 x 2970mm	R-281-O	700 x 2430mm	R-281-V	1000 x 2330mm
R-281-B	550 x 2330mm	R-281-I	650 x 2230mm	R-281-P	700 x 2970mm	R-281-W	1000 x 2430mm
R-281-C	550 x 2430mm	R-281-J	650 x 2330mm	R-281-Q	800 x 2230mm	R-281-X	1000 x 2970mm
R-281-D	550 x 2970mm	R-281-K	650 x 2430mm	R-281-R	800 x 2330mm	R-281-Y	1100 x 2230mm
R-281-E	600 x 2230mm	R-281-L	650 x 2970mm	R-281-S	800 x 2430mm	R-281-Z	1100 x 2330mm
R-281-F	600 x 2330mm	R-281-M	700 x 2230mm	R-281-T	800 x 2970mm	R-281-AA	1100 x 2430mm
R-281-G	600 x 2430mm	R-281-N	700 x 2330mm	R-281-U	1000 x 2230mm	R-281-AB	1100 x 2970mm

R-282

Ferragem Tampa Lateral Superior - Carreta com Fominha

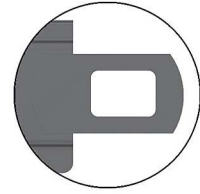
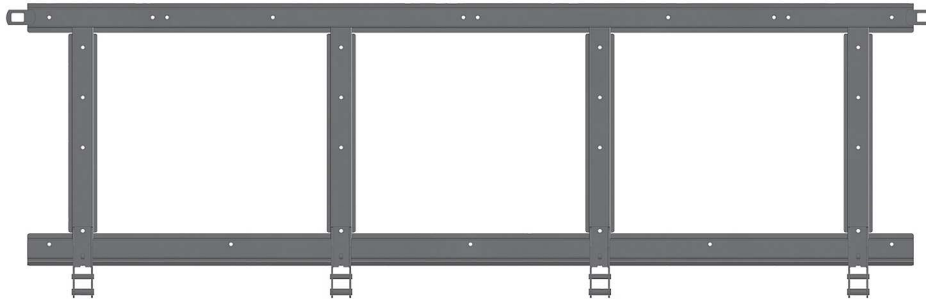
 Fueiro compatível:
 Altura da Presilha 18mm

COD.	MEDIDAS	COD.	MEDIDAS	COD.	MEDIDAS	COD.	MEDIDAS
R-282-A	550 x 2220mm	R-282-G	600 x 2420mm	R-282-M	700 x 2220mm	R-282-S	800 x 2420mm
R-282-B	550 x 2320mm	R-282-H	600 x 2960mm	R-282-N	700 x 2320mm	R-282-T	800 x 2960mm
R-282-C	550 x 2420mm	R-282-I	650 x 2220mm	R-282-O	700 x 2420mm	R-282-U	1000 x 2220mm
R-282-D	550 x 2960mm	R-282-J	650 x 2320mm	R-282-P	700 x 2960mm	R-282-V	1000 x 2320mm
R-282-E	600 x 2220mm	R-282-K	650 x 2420mm	R-282-Q	800 x 2220mm	R-282-W	1000 x 2420mm
R-282-F	600 x 2320mm	R-282-L	650 x 2960mm	R-282-R	800 x 2320mm	R-282-X	1000 x 2960mm

R-286

Ferragem Tampa Lateral Superior - Carreta sem Fominha

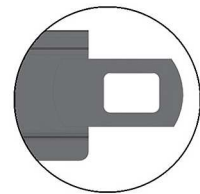
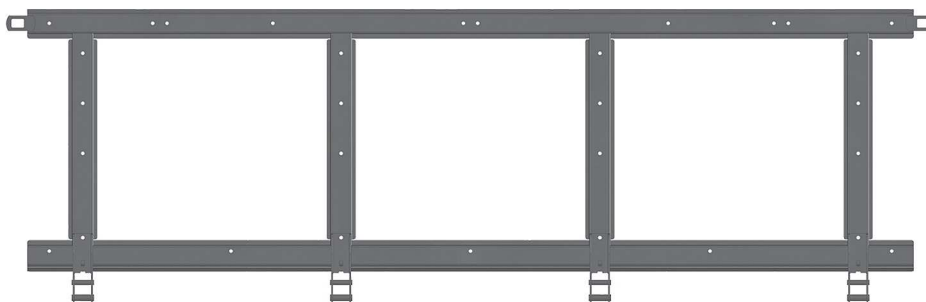
 Fueiro compatível:
 Altura da Presilha 18mm

COD.	MEDIDAS	COD.	MEDIDAS	COD.	MEDIDAS	COD.	MEDIDAS
R-286-A	550 x 2220mm	R-286-G	600 x 2420mm	R-286-M	700 x 2220mm	R-286-S	800 x 2420mm
R-286-B	550 x 2320mm	R-286-H	600 x 2960mm	R-286-N	700 x 2320mm	R-286-T	800 x 2960mm
R-286-C	550 x 2420mm	R-286-I	650 x 2220mm	R-286-O	700 x 2420mm	R-286-U	1000 x 2220mm
R-286-D	550 x 2960mm	R-286-J	650 x 2320mm	R-286-P	700 x 2960mm	R-286-V	1000 x 2320mm
R-286-E	600 x 2220mm	R-286-K	650 x 2420mm	R-286-Q	800 x 2220mm	R-286-W	1000 x 2420mm
R-286-F	600 x 2320mm	R-286-L	650 x 2960mm	R-286-R	800 x 2320mm	R-286-X	1000 x 2960mm

R-283

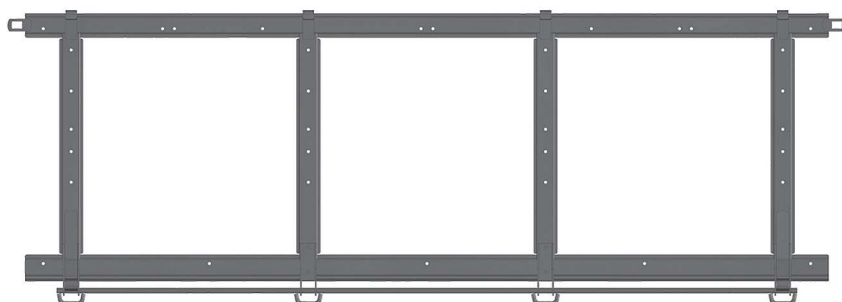
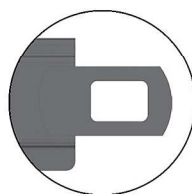
 Ferragem Tampa Traseira Inferior
 (com Tombador: R-289)

 Fueiro compatível:
 Altura da Presilha 18mm

COD.	MEDIDAS
R-283-A	550 x 2420mm
R-283-B	600 x 2420mm
R-283-C	650 x 2420mm
R-283-D	700 x 2420mm
R-283-E	800 x 2420mm
R-283-F	1000 x 2420mm
R-283-G	1100 X 2420mm

R-289

Conjunto do Tombador



COD.	DESCRIÇÃO
R-289	Conjunto do Tombador
R-289-A	Conjunto do Tombador c/4 Alavancas
R-289-B	Conjunto do Tombador c/Dobradiça Reforçada (espess.1/4")
R-289-C	Conjunto do Tombador c/4 Ganchos c/Dobrad.Reforç. (espess. 1/4")

R-284

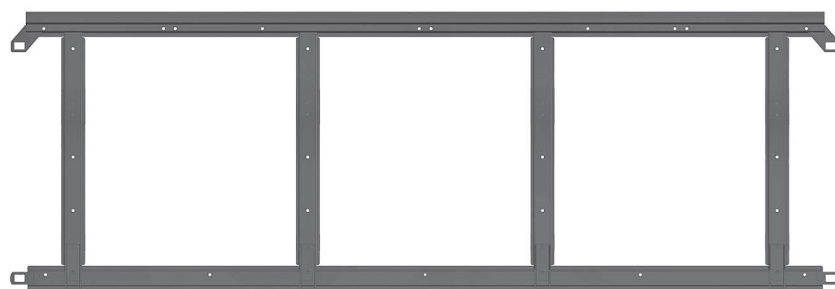
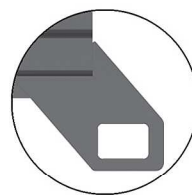
 Ferragem Tampa Traseira Superior
 Carreta com 2 Tampas

 Fueiro compatível:
 Altura da Presilha 81mm

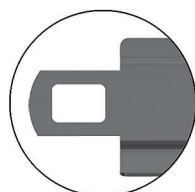
COD.	MEDIDAS
R-284-A	550 x 2430mm
R-284-B	600 x 2430mm
R-284-C	650 x 2430mm
R-284-D	700 x 2430mm
R-284-E	800 x 2430mm
R-284-F	1000 x 2430mm
R-284-G	1100 x 2430mm

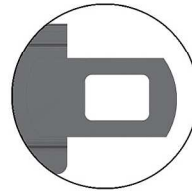

R-285

Ferragem Tampa Traseira Superior
Carreta com Fominha



Fueiro compatível:
Altura da Presilha 18mm

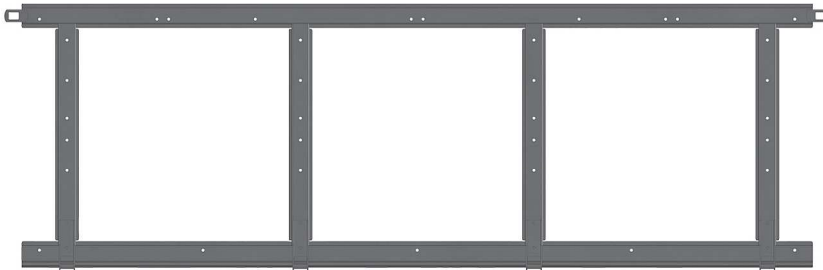

COD.	MEDIDAS
R-285-A	550 x 2420mm
R-285-B	600 x 2420mm
R-285-C	650 x 2420mm
R-285-D	700 x 2420mm
R-285-E	800 x 2420mm
R-285-F	1000 x 2420mm

R-287

Ferragem Tampa Traseira Superior
Carreta sem Fominha

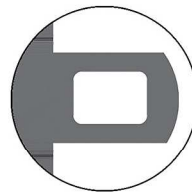

Fueiro compatível:
Altura da Presilha 18mm

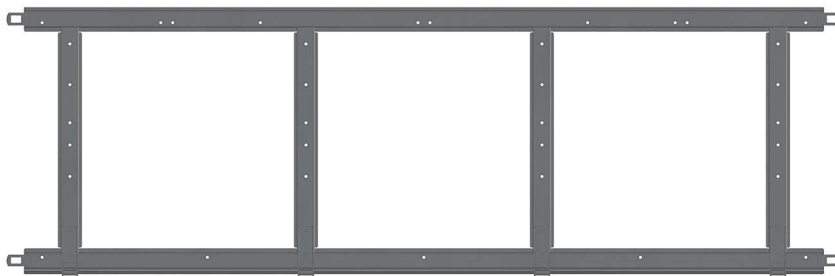

COD.	MEDIDAS
R-287-A	550 x 2420mm
R-287-B	600 x 2420mm
R-287-C	650 x 2420mm
R-287-D	700 x 2420mm
R-287-E	800 x 2420mm
R-287-F	1000 x 2420mm

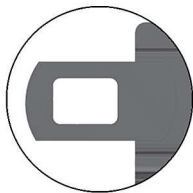

R-288

Ferragem Tampa Traseira Intermediária
Carreta com 03 Tampas

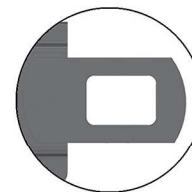

Fueiro compatível:
Altura da Presilha 18mm

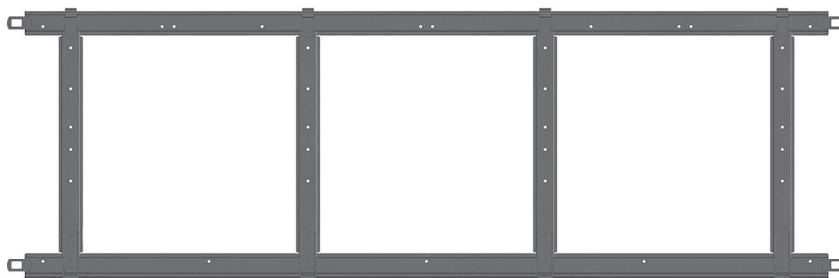

COD.	MEDIDAS
R-288-A	550 x 2420mm
R-288-B	600 x 2420mm
R-288-C	650 x 2420mm
R-288-D	700 x 2420mm
R-288-E	800 x 2420mm
R-288-F	1000 x 2420mm

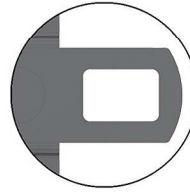
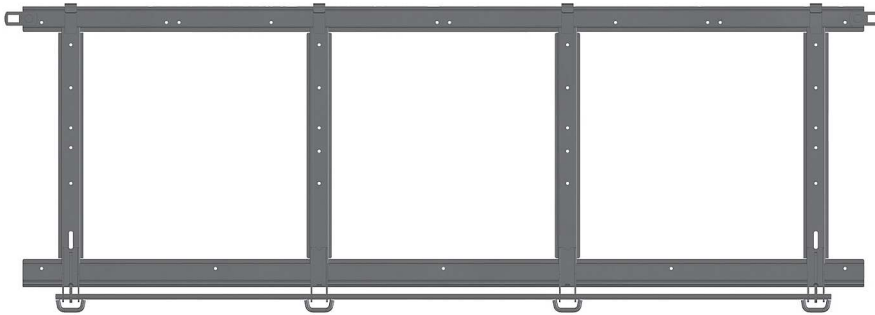

R-293

 Ferragem Tampa Traseira (Randon 70 anos)
 (com Tombador: R-290)

 Fueiro compatível:
 Altura da Presilha 18mm

COD.	MEDIDAS
R-293-A	550 x 2420mm
R-293-B	600 x 2420mm
R-293-C	650 x 2420mm
R-293-D	700 x 2420mm
R-293-E	800 x 2420mm
R-293-F	1000 x 2420mm
R-293-G	1100 x 2420mm

* Não acompanha alavanca do tombador (R-290-A).

R-290

Conjunto Tombador (Randon 70 anos)



* Não acompanha alavanca do tombador (R-290-A).

COD.	DESCRIÇÃO
R-290-A	Alavanca (vendido separadamente)
R-290-B	Conjunto Tombador (Randon 70 anos)
R-290-C	Conjunto Tombador (Randon 70 anos) c/Dobradiça Reforçada

R-291

Fueiro Tampa Traseira Inferior (Randon 70 anos)



COD.	MEDIDAS	ALT.TAMPA
R-291-A	430 mm	550 mm
R-291-B	480 mm	600 mm
R-291-C	530 mm	650 mm
R-291-D	580 mm	700 mm
R-291-E	680 mm	800 mm
R-291-F	880 mm	1000 mm
R-291-G	980 mm	1100 mm

R-172

Fueiro da Tampa Inferior

COD.	MEDIDAS	ALT. TAMPA
R-172-A	450 mm	550 mm
R-172-B	500 mm	600 mm
R-172-C	550 mm	650 mm
R-172-D	600 mm	700 mm
R-172-E	700 mm	800 mm
R-172-F	900 mm	1000 mm

R-171

Fueiro da Tampa Inferior c/Dobradiça

COD.	MEDIDAS	ALT. TAMPA
R-171-A	450 mm	550 mm
R-171-B	500 mm	600 mm
R-171-C	550 mm	650 mm
R-171-D	600 mm	700 mm
R-171-E	700 mm	800 mm
R-171-F	900 mm	1000 mm

R-174

Fueiro da Tampa Superior

COD.	MEDIDAS	ALT. TAMPA
R-174-A	450 mm	550 mm
R-174-B	500 mm	600 mm
R-174-C	550 mm	650 mm
R-174-D	600 mm	700 mm
R-174-E	700 mm	800 mm
R-174-F	900 mm	1000 mm
R-174-G	1000 mm	1100 mm

R-173

Fueiro da Tampa Superior c/Dobradiça

COD.	MEDIDAS	ALT. TAMPA
R-173-A	450 mm	550 mm
R-173-B	500 mm	600 mm
R-173-C	550 mm	650 mm
R-173-D	600 mm	700 mm
R-173-E	700 mm	800 mm
R-173-F	900 mm	1000 mm
R-173-G	1000 mm	1100 mm

R-178

Fueiro da Tampa Moderna

COD.	MEDIDAS	ALT. TAMPA
R-178-A	430 mm	550 mm
R-178-B	480 mm	600 mm
R-178-C	530 mm	650 mm
R-178-D	580 mm	700 mm
R-178-E	680 mm	800 mm
R-178-F	880 mm	1000 mm
R-178-G	980 mm	1100 mm

R-177

Fueiro da Tampa Moderna c/Dobradiça

COD.	MEDIDAS	ALT. TAMPA
R-177-A	430 mm	550 mm
R-177-B	480 mm	600 mm
R-177-C	530 mm	650 mm
R-177-D	580 mm	700 mm
R-177-E	680 mm	800 mm
R-177-F	880 mm	1000 mm
R-177-G	980 mm	1100 mm

CAIXAS / ENCAIXES DE FUEIROS

R-114
Caixa do Fueiro
(95mm) estampado



R-129
Caixa do Fueiro
(145mm) Modelo Largo

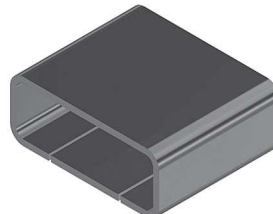

R-115
Encaixe do Fueiro Superior

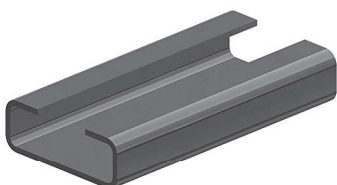

R-130
Encaixe do Fueiro Superior
Modelo Largo



DOBRADIÇAS

R-142
Dobradiça do Tombador Inferior
(155mm) chapa 4,25mm



R-142-A
Dobradiça do Tombador Inferior
(155mm) chapa 6,35mm

R-169
Dobradiça do Tombador
Superior (155mm)



R-175
Dobradiça da Tampa Antiga
(209mm)

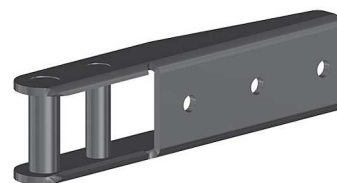

R-142-B
Dobradiça da Tampa Traseira
Inferior Mod. Randon 70 anos
(155mm)



R-142-C
Dobradiça da Tampa Traseira
Inferior Mod. Randon 70 anos
(155mm) (Reforçada 6,35mm)



R-176
Dobradiça da Tampa
Mod. Randon
(178mm)

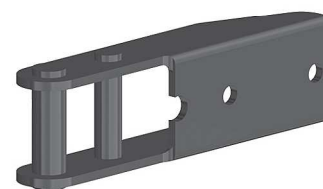

R-132

 Vigueta Inferior da Tampa Inferior e Superior
 com Furação

COD.	MEDIDAS
R-132-A	2220mm
R-132-B	2320mm
R-132-C	2420mm
R-132-D	2960mm

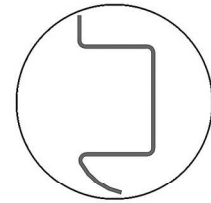
R-134

 Vigueta Superior da Tampa Inferior
 com Furação p/Presilha

COD.	MEDIDAS
R-134-A	2220mm
R-134-B	2320mm
R-134-C	2420mm
R-134-D	2960mm

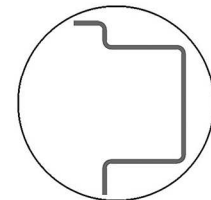
R-135

 Vigueta Superior da Tampa Superior
 com Furação p/Presilha e Arco c/Fominha

COD.	MEDIDAS
R-135-A	2220mm
R-135-B	2320mm
R-135-C	2420mm
R-135-D	2960mm



Vista da furação frontal

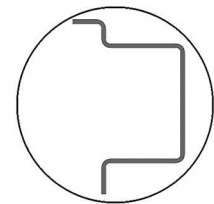

Vista da furação superior

R-137

 Vigueta Superior da Tampa Superior
 c/Quebra Lona com Furação (Brasilis)

COD.	MEDIDAS
R-137-A	2230mm
R-137-B	2330mm
R-137-C	2430mm
R-137-D	2970mm



Vista da furação frontal



Vista da furação superior

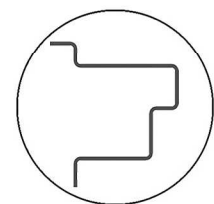

R-179-A

Engate Rápido Tampa Lat. (31,75mm)

R-179-B

Engate Rápido Tampa Lat. (34,50mm)

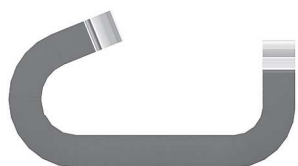

R-147

Engate Rápido Traseiro



R-139

Engate Fêmea Superior

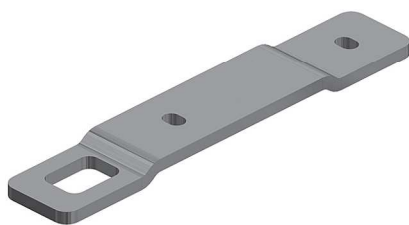

R-138

Engate Fêmea Inferior



R-116

Engate Fêmea Traseiro
(Linha R)

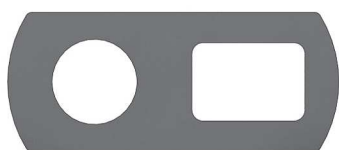

R-140

Engate Fêmea Fominha
Moderno

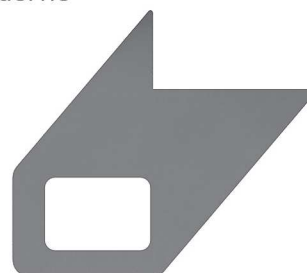

R-252-A

Engate Fêmea Reto 220mm

R-252-B

Engate Fêmea Reto 300mm

R-252-C

Engate Fêmea Reto 400mm



R-156

Engate "G" Fundido

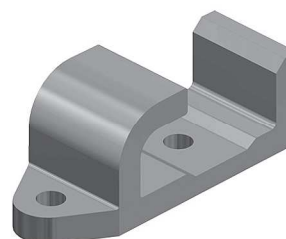

R-196

Cinta do Para-barro 640mm

R-196-A

Cinta do Para-barro 590mm

R-196-C

Cinta do Para-barro 670mm

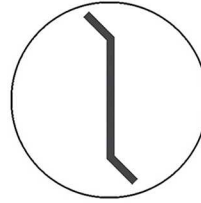

R-198-A

Suporte Central "Saia" 800mm

R-198-B

Suporte Central "Saia" 900mm



R-196-B

Cinta do Para-barro 590mm (Mod.2018)

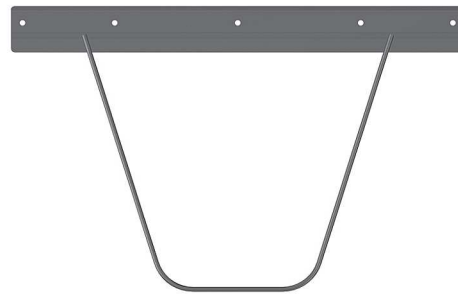

R-210

Pé de Apoio do Bitrem

(Modelo Reforçado)

Pé chapa 6,35mm

Suporte chapa 8,00mm

Medida Pé Aberto = 1640mm



R-380

Pé de Apoio do Bitrem

(Modelo Simples)

Pé chapa 4,25mm

Suporte chapa 6,35mm

Medida Pé Aberto = 1625mm

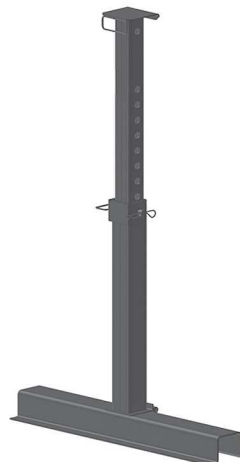

R-148-A

Guia da Fominha Antigo (178mm)



R-148-B

Guia da Fominha Moderno (160mm)

R-143

Gancho do Tombador

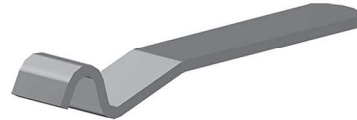

R-144

Deslizante do Tombador



R-145

Rolete do Tombador

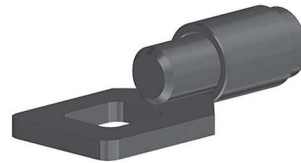

R-104

Estribo do Frontal



R-211

Engate da Cinta (Zincado Branco)



R-392

Suporte Cone Randon

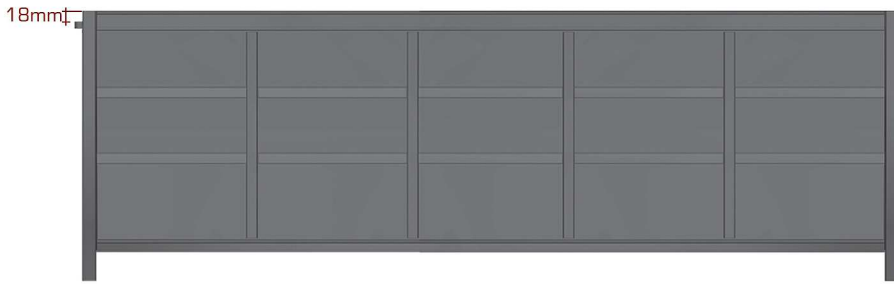

FRONTAIS - BATENTE ANTIGO / COM FRISO / RETO

G-401

 Frontal de Graneleira Inferior
 Batente Antigo

COD.	MEDIDAS
G-401-A	550 mm
G-401-B	600 mm
G-401-C	650 mm
G-401-D	700 mm
G-401-E	800 mm
G-401-F	1000 mm
G-401-G	1100 mm

G-413

 Frontal de Graneleira Inferior
 Batente Com Friso

COD.	MEDIDAS
G-413-A	550 mm
G-413-B	600 mm
G-413-C	650 mm
G-413-D	700 mm
G-413-E	800 mm
G-413-F	1000 mm
G-413-G	1100 mm

G-425

 Frontal de Graneleira Inferior
 Batente Reto

COD.	MEDIDAS
G-425-A	550 mm
G-425-B	600 mm
G-425-C	650 mm
G-425-D	700 mm
G-425-E	800 mm
G-425-F	1000 mm
G-425-G	1100 mm

G-402

 Frontal de Graneleira Superior
 Batente Antigo

COD.	MEDIDAS
G-402-A	550 mm
G-402-B	600 mm
G-402-C	650 mm
G-402-D	700 mm
G-402-E	800 mm
G-402-F	1000 mm
G-402-G	1100 mm

G-414

 Frontal de Graneleira Superior
 Batente Com Friso

COD.	MEDIDAS
G-414-A	550 mm
G-414-B	600 mm
G-414-C	650 mm
G-414-D	700 mm
G-414-E	800 mm
G-414-F	1000 mm
G-414-G	1100 mm

G-426

 Frontal de Graneleira Superior
 Batente Reto

COD.	MEDIDAS
G-426-A	550 mm
G-426-B	600 mm
G-426-C	650 mm
G-426-D	700 mm
G-426-E	800 mm
G-426-F	1000 mm
G-426-G	1100 mm

FRONTAIS - BATENTE ANTIGO / COM FRISO / RETO

G-403

 Frontal de Graneleira Fominha
 Batente Antigo

COD.	MEDIDAS
G-403-A	300 mm
G-403-B	400 mm

G-415

 Frontal de Graneleira Fominha
 Batente Com Friso

COD.	MEDIDAS
G-415-A	300 mm
G-415-B	400 mm

G-427

 Frontal de Graneleira Fominha
 Batente Reto

COD.	MEDIDAS
G-427-A	300 mm
G-427-B	400 mm

FUEIROS - FOMINHA

BATENTE ANTIGO / 104mm

BATENTE C/FRISO / 104mm

BATENTE RETO / 104mm

G-406

Fueiro Lateral Fominha

COD.	MEDIDAS
G-406-A	300 mm
G-406-B	400 mm

G-418

Fueiro Lateral Fominha

COD.	MEDIDAS
G-418-A	300 mm
G-418-B	400 mm

G-430

Fueiro Lateral Fominha

COD.	MEDIDAS
G-430-A	300 mm
G-430-B	400 mm

G-411

Fueiro Canto Fominha Dir.

COD.	MEDIDAS
G-411-A	300 mm
G-411-B	400 mm

G-423

Fueiro Canto Fominha Dir.

COD.	MEDIDAS
G-423-A	300 mm
G-423-B	400 mm

G-435

Fueiro Canto Fominha Dir.

COD.	MEDIDAS
G-435-A	300 mm
G-435-B	400 mm

G-412

Fueiro Canto Fominha Esq.

COD.	MEDIDAS
G-412-A	300 mm
G-412-B	400 mm

G-424

Fueiro Canto Fominha Esq.

COD.	MEDIDAS
G-424-A	300 mm
G-424-B	400 mm

G-436

Fueiro Canto Fominha Esq.

COD.	MEDIDAS
G-436-A	300 mm
G-436-B	400 mm

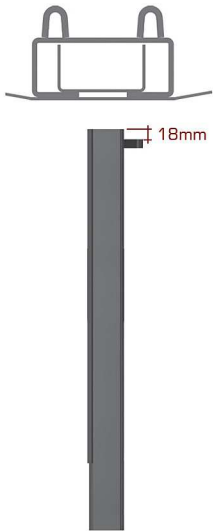
FUEIROS - BATENTE ANTIGO / largura 104mm

G-404

Fueiro Lateral Inferior

COD.	MEDIDAS
G-404-A	550 mm
G-404-B	600 mm
G-404-C	650 mm
G-404-D	700 mm
G-404-E	800 mm
G-404-F	1000 mm
G-404-G	1100 mm

* Compatível com G-520 / G-530

G-405

Fueiro Lateral Superior

COD.	MEDIDAS
G-405-A	550 mm
G-405-B	600 mm
G-405-C	650 mm
G-405-D	700 mm
G-405-E	800 mm
G-405-F	1000 mm
G-405-G	1100 mm

* Compatível com G-522 / G-532

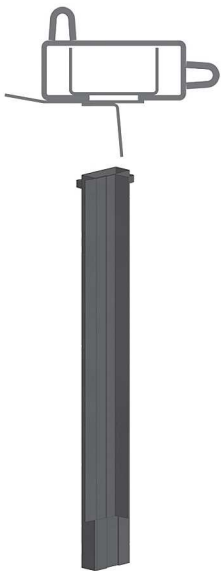
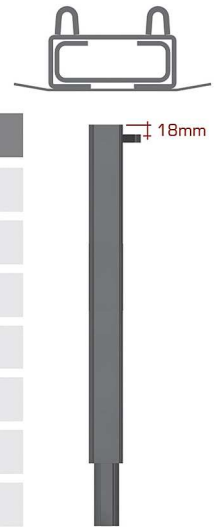
G-407

Fueiro Canto Inferior Direito

COD.	MEDIDAS
G-407-A	550 mm
G-407-B	600 mm
G-407-C	650 mm
G-407-D	700 mm
G-407-E	800 mm
G-407-F	1000 mm
G-407-G	1100 mm

* Compatível com G-520 / G-530

G-408

Fueiro Canto Inferior Esquerdo

COD.	MEDIDAS
G-408-A	550 mm
G-408-B	600 mm
G-408-C	650 mm
G-408-D	700 mm
G-408-E	800 mm
G-408-F	1000 mm
G-408-G	1100 mm

* Compatível com G-520 / G-530

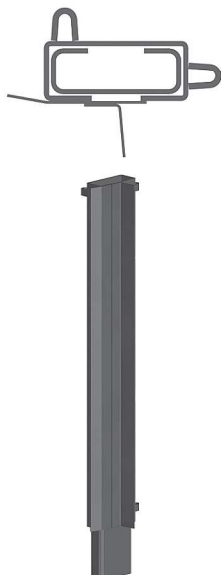
G-409

Fueiro Canto Superior Direito

COD.	MEDIDAS
G-409-A	550 mm
G-409-B	600 mm
G-409-C	650 mm
G-409-D	700 mm
G-409-E	800 mm
G-409-F	1000 mm
G-409-G	1100 mm

* Compatível com G-522 / G-532

G-410

Fueiro Canto Superior Esquerdo

COD.	MEDIDAS
G-410-A	550 mm
G-410-B	600 mm
G-410-C	650 mm
G-410-D	700 mm
G-410-E	800 mm
G-410-F	1000 mm
G-410-G	1100 mm

* Compatível com G-522 / G-532

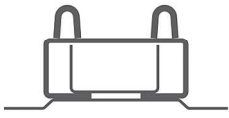
FUEIROS - BATENTE COM FRISO / largura 104mm

G-416

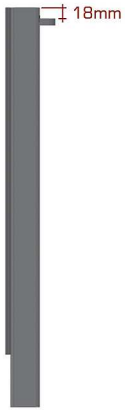
Fueiro Lateral Inferior



COD.	MEDIDAS
G-416-A	550 mm
G-416-B	600 mm
G-416-C	650 mm
G-416-D	700 mm
G-416-E	800 mm
G-416-F	1000 mm
G-416-G	1100 mm

* Compatível com G-520 / G-530

G-417

Fueiro Lateral Superior



COD.	MEDIDAS
G-417-A	550 mm
G-417-B	600 mm
G-417-C	650 mm
G-417-D	700 mm
G-417-E	800 mm
G-417-F	1000 mm
G-417-G	1100 mm

* Compatível com G-521 / G-531

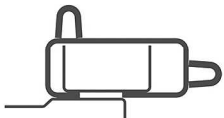
G-419

Fueiro Canto Inferior Direito



COD.	MEDIDAS
G-419-A	550 mm
G-419-B	600 mm
G-419-C	650 mm
G-419-D	700 mm
G-419-E	800 mm
G-419-F	1000 mm
G-419-G	1100 mm

* Compatível com G-520 / G-530

G-420

Fueiro Canto Inferior Esquerdo

COD.	MEDIDAS
G-420-A	550 mm
G-420-B	600 mm
G-420-C	650 mm
G-420-D	700 mm
G-420-E	800 mm
G-420-F	1000 mm
G-420-G	1100 mm

* Compatível com G-520 / G-530

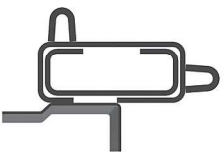
G-421

Fueiro Canto Superior Direito

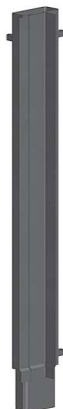

COD.	MEDIDAS
G-421-A	550 mm
G-421-B	600 mm
G-421-C	650 mm
G-421-D	700 mm
G-421-E	800 mm
G-421-F	1000 mm
G-421-G	1100 mm

* Compatível com G-521 / G-531

G-422

Fueiro Canto Superior Esquerdo

COD.	MEDIDAS
G-422-A	550 mm
G-422-B	600 mm
G-422-C	650 mm
G-422-D	700 mm
G-422-E	800 mm
G-422-F	1000 mm
G-422-G	1100 mm

* Compatível com G-521 / G-531

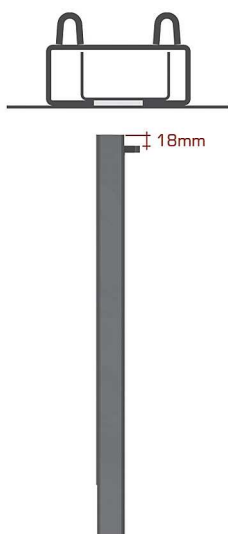
FUEIROS - BATENTE RETO / largura 104mm

G-428

Fueiro Lateral Inferior

COD.	MEDIDAS
G-428-A	550 mm
G-428-B	600 mm
G-428-C	650 mm
G-428-D	700 mm
G-428-E	800 mm
G-428-F	1000 mm
G-428-G	1100 mm

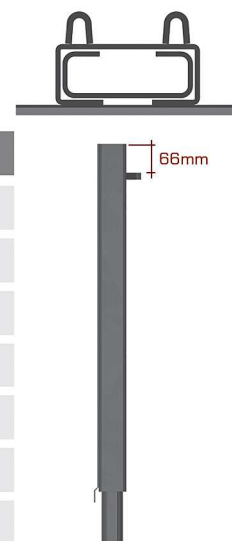
* Compatível com G-520 / G-530

G-429

Fueiro Lateral Superior

COD.	MEDIDAS
G-429-A	550 mm
G-429-B	600 mm
G-429-C	650 mm
G-429-D	700 mm
G-429-E	800 mm
G-429-F	1000 mm
G-429-G	1100 mm

* Compatível com G-521 / G-531

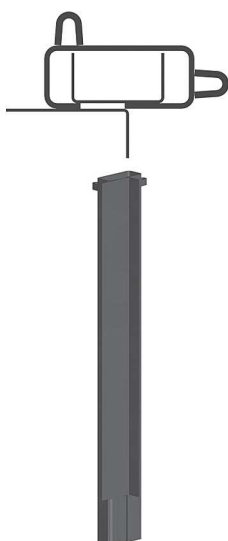
G-431

Fueiro Canto Inferior Direito

COD.	MEDIDAS
G-431-A	550 mm
G-431-B	600 mm
G-431-C	650 mm
G-431-D	700 mm
G-431-E	800 mm
G-431-F	1000 mm
G-431-G	1100 mm

* Compatível com G-520 / G-530

G-432

Fueiro Canto Inferior Esquerdo

COD.	MEDIDAS
G-432-A	550 mm
G-432-B	600 mm
G-432-C	650 mm
G-432-D	700 mm
G-432-E	800 mm
G-432-F	1000 mm
G-432-G	1100 mm

* Compatível com G-520 / G-530

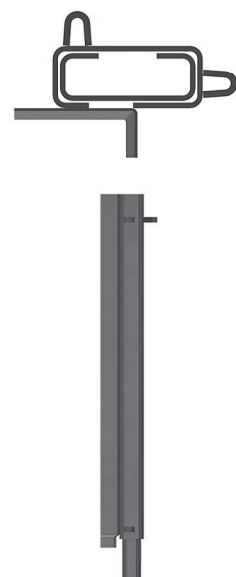
G-433

Fueiro Canto Superior Direito

COD.	MEDIDAS
G-433-A	550 mm
G-433-B	600 mm
G-433-C	650 mm
G-433-D	700 mm
G-433-E	800 mm
G-433-F	1000 mm
G-433-G	1100 mm

* Compatível com G-521 / G-531

G-434

Fueiro Canto Superior Esquerdo

COD.	MEDIDAS
G-434-A	550 mm
G-434-B	600 mm
G-434-C	650 mm
G-434-D	700 mm
G-434-E	800 mm
G-434-F	1000 mm
G-434-G	1100 mm

* Compatível com G-521 / G-531

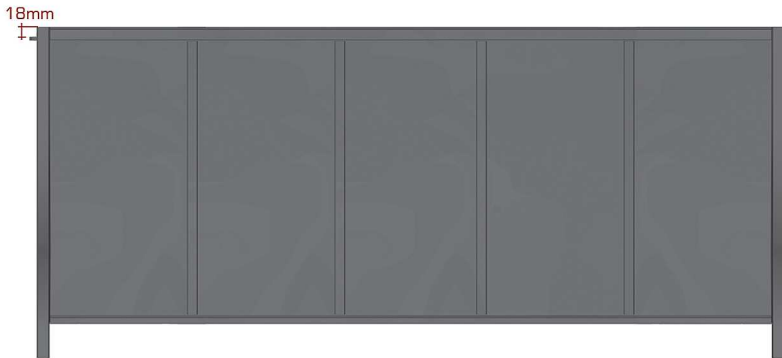
FRONTAIS - FOLHA LISA

G-452

 Frontal de Graneleira Inferior
 Batente Antigo

COD.	MEDIDAS
G-452-A	550 mm
G-452-B	600 mm
G-452-C	650 mm
G-452-D	700 mm
G-452-E	800 mm
G-452-F	1000 mm

G-454

 Frontal de Graneleira Inferior
 Batente Com Friso

COD.	MEDIDAS
G-454-A	550 mm
G-454-B	600 mm
G-454-C	650 mm
G-454-D	700 mm
G-454-E	800 mm
G-454-F	1000 mm

G-456

 Frontal de Graneleira Inferior
 Batente Reto

COD.	MEDIDAS
G-456-A	550 mm
G-456-B	600 mm
G-456-C	650 mm
G-456-D	700 mm
G-456-E	800 mm
G-456-F	1000 mm

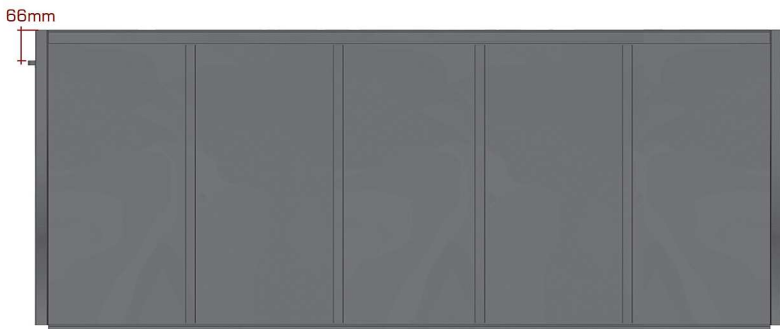
G-453

 Frontal de Graneleira Superior
 Batente Antigo

COD.	MEDIDAS
G-453-A	550 mm
G-453-B	600 mm
G-453-C	650 mm
G-453-D	700 mm
G-453-E	800 mm
G-453-F	1000 mm

G-455

 Frontal de Graneleira Superior
 Batente Com Friso

COD.	MEDIDAS
G-455-A	550 mm
G-455-B	600 mm
G-455-C	650 mm
G-455-D	700 mm
G-455-E	800 mm
G-455-F	1000 mm

G-457

 Frontal de Graneleira Superior
 Batente Reto

COD.	MEDIDAS
G-457-A	550 mm
G-457-B	600 mm
G-457-C	650 mm
G-457-D	700 mm
G-457-E	800 mm
G-457-F	1000 mm

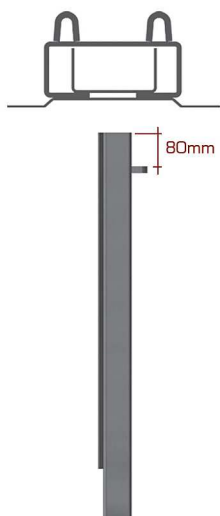
G-507

Fuego Lateral Inferior

COD.	MEDIDAS
G-507-A	550 mm
G-507-B	600 mm
G-507-C	650 mm
G-507-D	700 mm
G-507-E	800 mm
G-507-F	1000 mm

* Compatível com G-520 / G-530

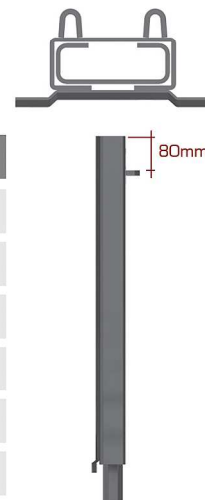
G-612

Fuego Lateral Superior

COD.	MEDIDAS
G-612-A	550 mm
G-612-B	600 mm
G-612-C	650 mm
G-612-D	700 mm
G-612-E	800 mm
G-612-F	1000 mm

* Compatível com G-521 / G-531

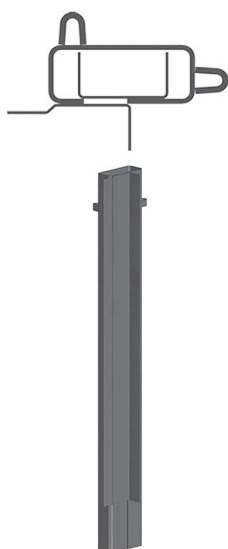
G-508

Fuego Canto Inferior Direito

COD.	MEDIDAS
G-508-A	550 mm
G-508-B	600 mm
G-508-C	650 mm
G-508-D	700 mm
G-508-E	800 mm
G-508-F	1000 mm

* Compatível com G-520 / G-530

G-509

Fuego Canto Inferior Esquerdo

COD.	MEDIDAS
G-509-A	550 mm
G-509-B	600 mm
G-509-C	650 mm
G-509-D	700 mm
G-509-E	800 mm
G-509-F	1000 mm

* Compatível com G-520 / G-530

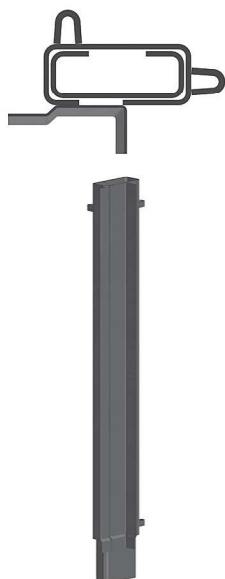
G-613

Fuego Canto Superior Direito

COD.	MEDIDAS
G-613-A	550 mm
G-613-B	600 mm
G-613-C	650 mm
G-613-D	700 mm
G-613-E	800 mm
G-613-F	1000 mm

* Compatível com G-521 / G-531

G-614

Fuego Canto Superior Esquerdo

COD.	MEDIDAS
G-614-A	550 mm
G-614-B	600 mm
G-614-C	650 mm
G-614-D	700 mm
G-614-E	800 mm
G-614-F	1000 mm

* Compatível com G-521 / G-531

FUEIROS / largura 145mm

G-537
 Fueiro Lateral Inferior C/Friso

COD.	MEDIDAS
G-537-A	550 mm
G-537-B	600 mm
G-537-C	650 mm
G-537-D	700 mm
G-537-E	800 mm
G-537-F	1000 mm



G-538
 Fueiro Lateral Superior C/Friso

COD.	MEDIDAS
G-538-A	550 mm
G-538-B	600 mm
G-538-C	650 mm
G-538-D	700 mm
G-538-E	800 mm
G-538-F	1000 mm

G-539
 Caixa de Fueiro
 Modelo 145mm

FUEIROS / largura 175mm

G-540
 Fueiro Lateral Inferior C/Friso

COD.	MEDIDAS
G-540-A	550 mm
G-540-B	600 mm
G-540-C	650 mm
G-540-D	700 mm
G-540-E	800 mm
G-540-F	1000 mm



G-541
 Fueiro Lateral Superior C/Friso

COD.	MEDIDAS
G-541-A	550 mm
G-541-B	600 mm
G-541-C	650 mm
G-541-D	700 mm
G-541-E	800 mm
G-541-F	1000 mm

G-542
 Caixa de Fueiro
 Modelo 175mm

FERRAGENS - TAMPA DE MADEIRA

G-520
 Ferragem Tampa Lateral Inferior

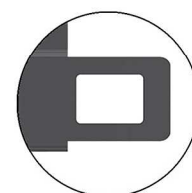
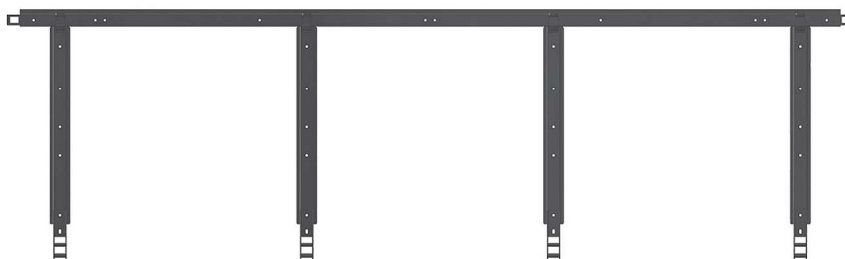

Fueiro compatível:
 Altura da Presilha 18mm

COD.	MEDIDAS	COD.	MEDIDAS	COD.	MEDIDAS
G-520-A	550 x 2212mm	G-520-G	650 x 2212mm	G-520-M	800 x 2212mm
G-520-B	550 x 2430mm	G-520-H	650 x 2430mm	G-520-N	800 x 2430mm
G-520-C	550 x 2960mm	G-520-I	650 x 2960mm	G-520-O	800 x 2960mm
G-520-D	600 x 2212mm	G-520-J	700 x 2212mm	G-520-P	1000 x 2212mm
G-520-E	600 x 2430mm	G-520-K	700 x 2430mm	G-520-Q	1000 x 2430mm
G-520-F	600 x 2960mm	G-520-L	700 x 2960mm	G-520-R	1000 x 2960mm

COD.	MEDIDAS
G-520-S	1100 x 2212mm
G-520-T	1100 x 2430mm
G-520-U	1100 x 2960mm

FERRAGENS - TAMPA DE MADEIRA
G-521

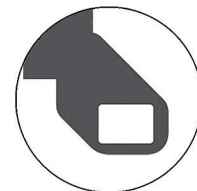
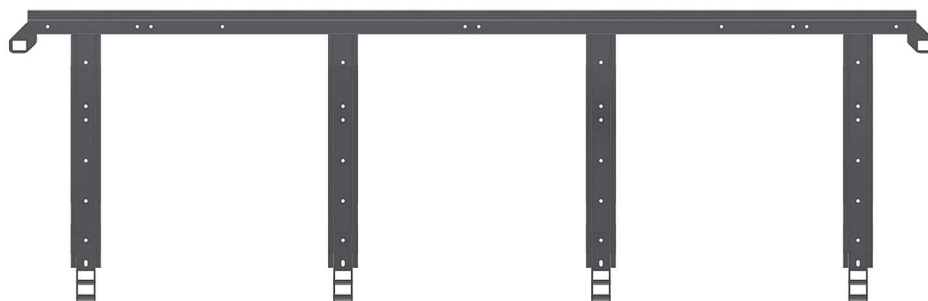
 Ferragem Tampa Lateral Superior
 Carreta com 2 Tampas

 Fueiro compatível:
 Altura da Presilha 66mm

COD.	MEDIDAS	COD.	MEDIDAS	COD.	MEDIDAS	COD.	MEDIDAS
G-521-A	550 x 2212mm	G-521-G	650 x 2212mm	G-521-M	800 x 2212mm		
G-521-B	550 x 2430mm	G-521-H	650 x 2430mm	G-521-N	800 x 2430mm		
G-521-C	550 x 2960mm	G-521-I	650 x 2960mm	G-521-O	800 x 2960mm		
G-521-D	600 x 2212mm	G-521-J	700 x 2212mm	G-521-P	1000 x 2212mm		
G-521-E	600 x 2430mm	G-521-K	700 x 2430mm	G-521-Q	1000 x 2430mm		
G-521-F	600 x 2960mm	G-521-L	700 x 2960mm	G-521-R	1000 x 2960mm		

COD.	MEDIDAS
G-521-S	1100 x 2212mm
G-521-T	1100 x 2430mm
G-521-U	1100 x 2960mm

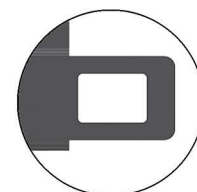
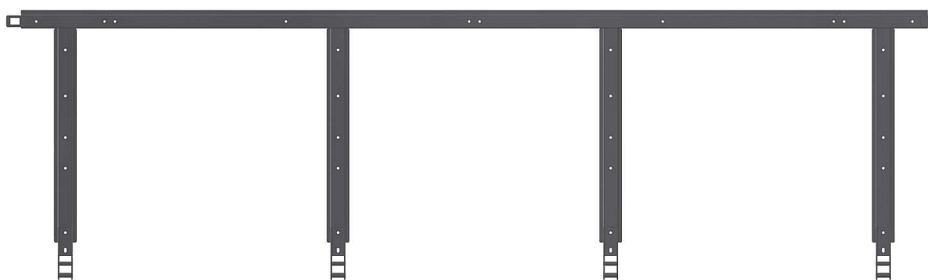
G-522

 Ferragem Tampa Lateral Superior
 Carreta com Fominha

 Fueiro compatível:
 Altura da Presilha 18mm

COD.	MEDIDAS	COD.	MEDIDAS	COD.	MEDIDAS	COD.	MEDIDAS
G-522-A	550 x 2212mm	G-522-G	650 x 2212mm	G-522-M	800 x 2212mm		
G-522-B	550 x 2430mm	G-522-H	650 x 2430mm	G-522-N	800 x 2430mm		
G-522-C	550 x 2960mm	G-522-I	650 x 2960mm	G-522-O	800 x 2960mm		
G-522-D	600 x 2212mm	G-522-J	700 x 2212mm	G-522-P	1000 x 2212mm		
G-522-E	600 x 2430mm	G-522-K	700 x 2430mm	G-522-Q	1000 x 2430mm		
G-522-F	600 x 2960mm	G-522-L	700 x 2960mm	G-522-R	1000 x 2960mm		

COD.	MEDIDAS
G-522-S	1100 x 2212mm
G-522-T	1100 x 2430mm
G-522-U	1100 x 2960mm

FERRAGENS - TAMPA DE MADEIRA

G-523

Ferragem Tampa Traseira Inferior
(com Tombador)

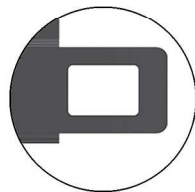

Fueiro compatível:

Altura da Presilha 18mm

COD.	MEDIDAS
G-523-A	550 x 2430mm
G-523-B	600 x 2430mm
G-523-C	650 x 2430mm
G-523-D	700 x 2430mm
G-523-E	800 x 2430mm
G-523-F	1000 x 2430mm
G-523-G	1100 x 2430mm

G-536

Conjunto do Tombador



COD.	DESCRIÇÃO
G-536	Conjunto do Tombador
G-536-A	Conjunto do Tombador c/4 Travas
G-536-B	Conjunto do Tombador c/Dobradiça Reforçada
G-536-C	Conjunto do Tombador c/4 Ganchos e Dobradiça Reforçada

G-524

Ferragem Tampa Traseira Superior
Carreta com 2 Tampas

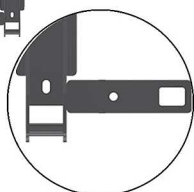
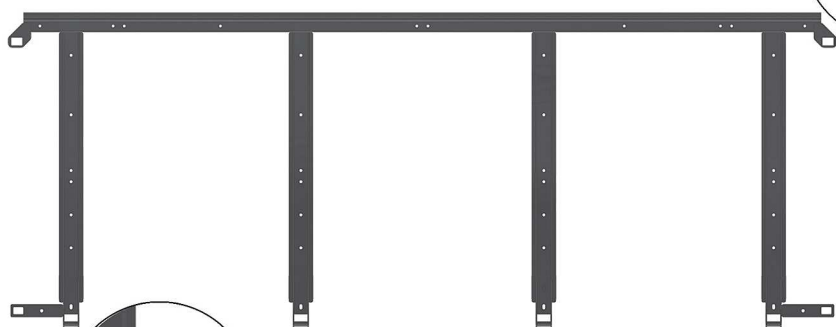
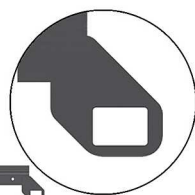

Fueiro compatível:

Altura da Presilha 66mm

COD.	MEDIDAS
G-524-A	550 x 2430mm
G-524-B	600 x 2430mm
G-524-C	650 x 2430mm
G-524-D	700 x 2430mm
G-524-E	800 x 2430mm
G-524-F	1000 x 2430mm
G-524-G	1100 x 2430mm

G-525

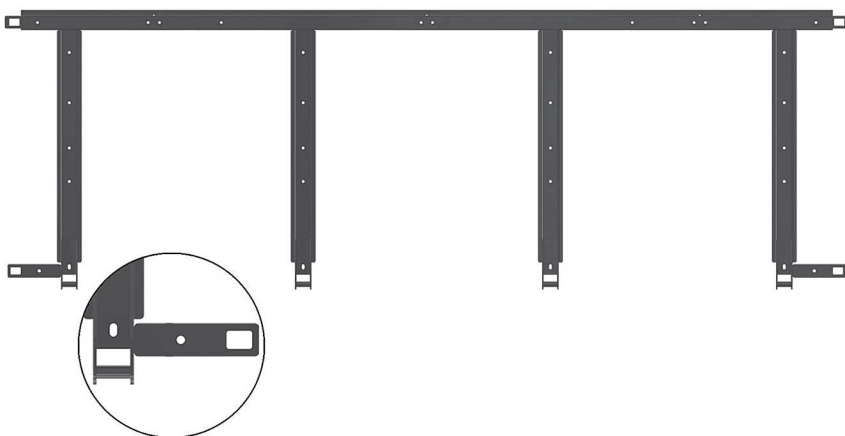
 Ferragem Tapa Traseira Superior
 Carreta com Fominha

 Fueiro compatível:
 Altura da Presilha 18mm

COD.	MEDIDAS
G-525-A	550 x 2430mm
G-525-B	600 x 2430mm
G-525-C	650 x 2430mm
G-525-D	700 x 2430mm
G-525-E	800 x 2430mm
G-525-F	1000 x 2430mm
G-525-G	1100 x 2430mm

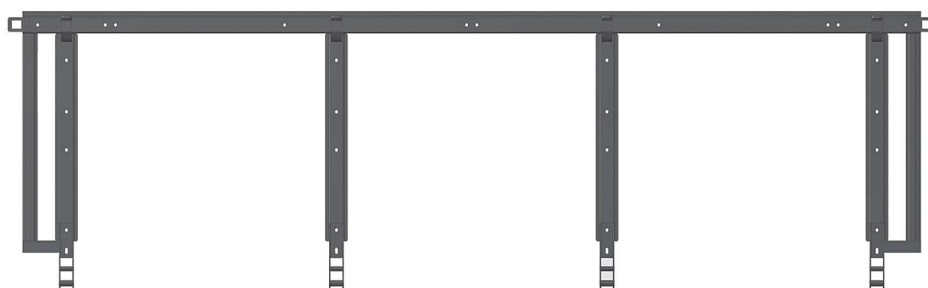
G-530

 Ferragem Tapa Lateral Inferior
 Tapa Plástica

 Fueiro compatível:
 Altura da Presilha 18mm

COD.	MEDIDAS	COD.	MEDIDAS	COD.	MEDIDAS
G-530-A	550 x 2212mm	G-530-G	650 x 2212mm	G-530-M	800 x 2212mm
G-530-B	550 x 2430mm	G-530-H	650 x 2430mm	G-530-N	800 x 2430mm
G-530-C	550 x 2965mm	G-530-I	650 x 2965mm	G-530-O	800 x 2965mm
G-530-D	600 x 2212mm	G-530-J	700 x 2212mm	G-530-P	1000 x 2212mm
G-530-E	600 x 2430mm	G-530-K	700 x 2430mm	G-530-Q	1000 x 2430mm
G-530-F	600 x 2965mm	G-530-L	700 x 2965mm	G-530-R	1000 x 2965mm

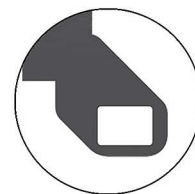
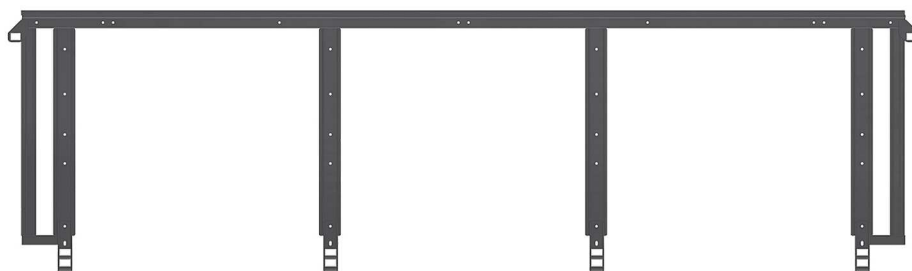
G-531

 Ferragem Tampa Lateral Superior
 Carreta com 2 Tampas Plásticas

 Fueiro compatível:
 Altura da Presilha 66mm

COD.	MEDIDAS	COD.	MEDIDAS	COD.	MEDIDAS
G-531-A	550 x 2212mm	G-531-G	650 x 2212mm	G-531-M	800 x 2212mm
G-531-B	550 x 2430mm	G-531-H	650 x 2430mm	G-531-N	800 x 2430mm
G-531-C	550 x 2965mm	G-531-I	650 x 2965mm	G-531-O	800 x 2965mm
G-531-D	600 x 2212mm	G-531-J	700 x 2212mm	G-531-P	1000 x 2212mm
G-531-E	600 x 2430mm	G-531-K	700 x 2430mm	G-531-Q	1000 x 2430mm
G-531-F	600 x 2965mm	G-531-L	700 x 2965mm	G-531-R	1000 x 2965mm

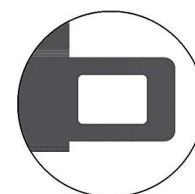
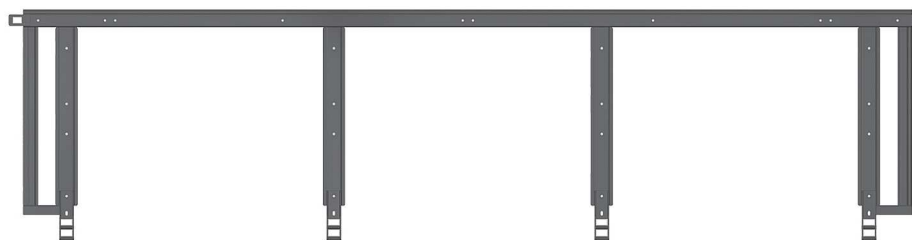
G-532

 Ferragem Tampa Lateral Superior
 Carreta com Fominha Tampa Plástica

 Fueiro compatível:
 Altura da Presilha 18mm

COD.	MEDIDAS	COD.	MEDIDAS	COD.	MEDIDAS
G-532-A	550 x 2212mm	G-532-G	650 x 2212mm	G-532-M	800 x 2212mm
G-532-B	550 x 2430mm	G-532-H	650 x 2430mm	G-532-N	800 x 2430mm
G-532-C	550 x 2965mm	G-532-I	650 x 2965mm	G-532-O	800 x 2965mm
G-532-D	600 x 2212mm	G-532-J	700 x 2212mm	G-532-P	1000 x 2212mm
G-532-E	600 x 2430mm	G-532-K	700 x 2430mm	G-532-Q	1000 x 2430mm
G-532-F	600 x 2965mm	G-532-L	700 x 2965mm	G-532-R	1000 x 2965mm

G-533

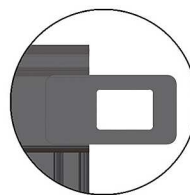
Ferragem Tampa Traseira Inferior
Tampa Plástica (com Tombador)



Fueiro compatível:
Altura da Presilha 18mm



Tombador G-536-A

COD.	MEDIDAS
G-533-A	550 x 2430mm
G-533-B	600 x 2430mm
G-533-C	650 x 2430mm
G-533-D	700 x 2430mm
G-533-E	800 x 2430mm
G-533-F	1000 x 2430mm

G-534

Ferragem Tampa Traseira Superior
Carreta com 2 Tampas

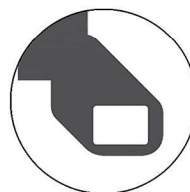

Fueiro compatível:
Altura da Presilha 66mm

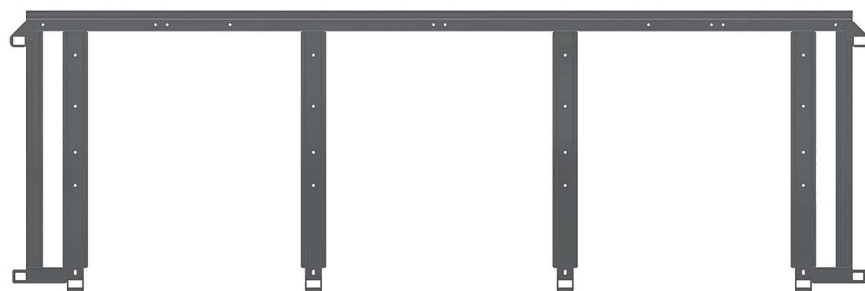

COD.	MEDIDAS
G-534-A	550 x 2430mm
G-534-B	600 x 2430mm
G-534-C	650 x 2430mm
G-534-D	700 x 2430mm
G-534-E	800 x 2430mm
G-534-F	1000 x 2430mm

G-535

Ferragem Tampa Traseira Superior
Carreta com Fominha

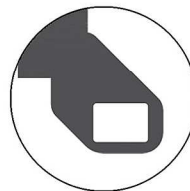

Fueiro compatível:
Altura da Presilha 66mm



COD.	MEDIDAS
G-535-A	550 x 2430mm
G-535-B	600 x 2430mm
G-535-C	650 x 2430mm
G-535-D	700 x 2430mm
G-535-E	800 x 2430mm
G-535-F	1000 x 2430mm

G-543

Ferragem Lateral Inferior

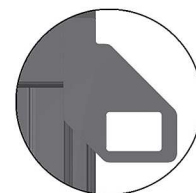
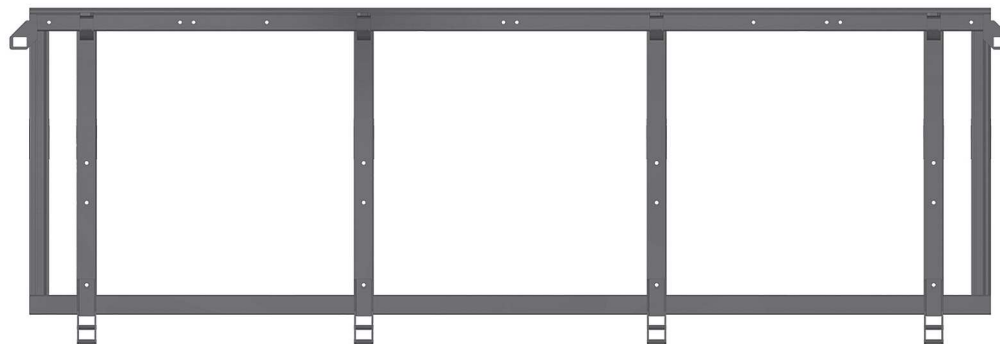

Fueiro compatível:
Altura da Presilha 80mm

COD.	MEDIDAS	COD.	MEDIDAS	COD.	MEDIDAS
G-543-A	635 x 2212mm	G-543-D	785 x 2212mm	G-543-G	985 x 2212mm
G-543-B	635 x 2430mm	G-543-E	785 x 2430mm	G-543-H	985 x 2430mm
G-543-C	635 x 2965mm	G-543-F	785 x 2965mm	G-543-I	985 x 2965mm

G-544

Ferragem Lateral Superior

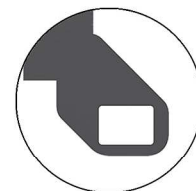
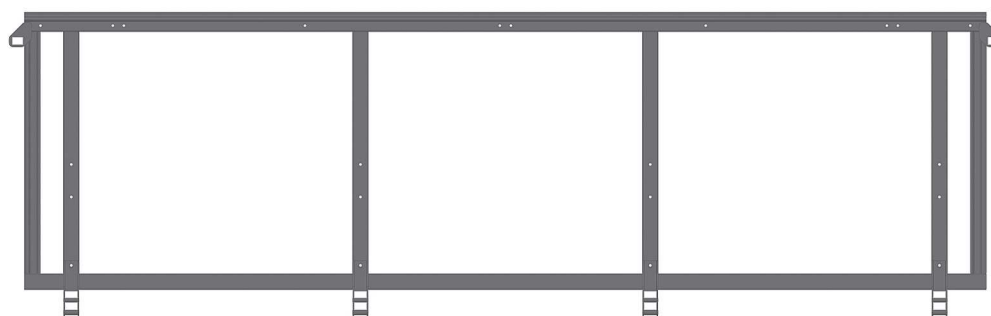

Fueiro compatível:
Altura da Presilha 80mm

COD.	MEDIDAS	COD.	MEDIDAS	COD.	MEDIDAS
G-544-A	635 x 2212mm	G-544-D	785 x 2212mm	G-544-G	985 x 2212mm
G-544-B	635 x 2430mm	G-544-E	785 x 2430mm	G-544-H	985 x 2430mm
G-544-C	635 x 2965mm	G-544-F	785 x 2965mm	G-544-I	985 x 2965mm

G-545

Ferragem Lateral - Carga Seca

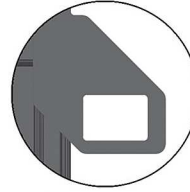

Fueiro compatível:
Altura da Presilha 80mm

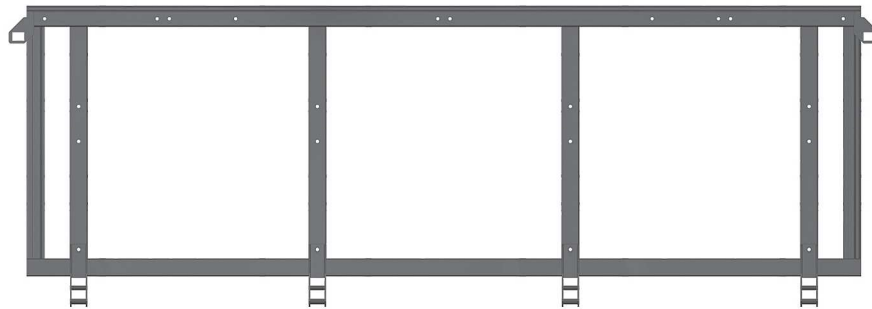

COD.	MEDIDAS
G-545-A	535 x 2212mm
G-545-B	535 x 2430mm
G-545-C	535 x 2965mm

Obs. G-545-B => Ferragem Lateral/Traseira

G-546

Ferragem Traseira Inferior
(com Tombador)

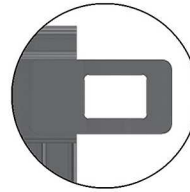

Fueiro compatível:
Altura da Presilha 18mm

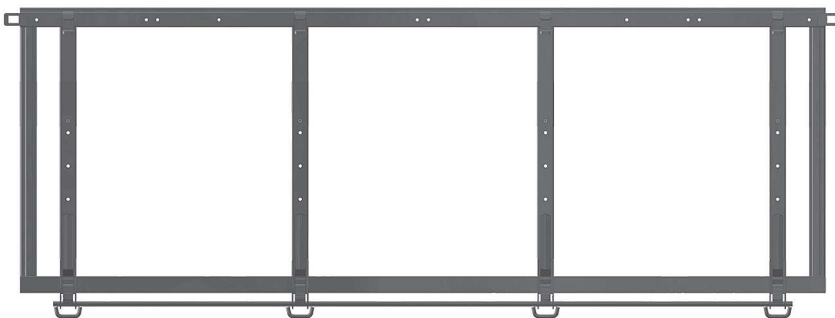

Tombador G-536-A

COD.	MEDIDAS
G-546-A	635 x 2430mm
G-546-B	785 x 2430mm
G-546-C	985 x 2430mm

G-547

Ferragem Traseira Superior

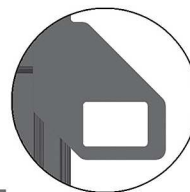

Fueiro compatível:
Altura da Presilha 80mm

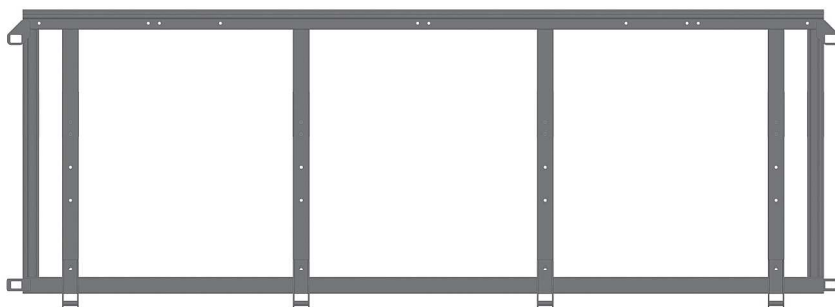

COD.	MEDIDAS
G-547-A	635 x 2430mm
G-547-B	785 x 2430mm
G-547-C	985 x 2430mm

VIGUETAS - TAMPA DE MADEIRA
G-502

 Vigueta Superior da Tamba Inferior com Furação p/Presilha

COD.	MEDIDAS
G-502-A	2212mm
G-502-B	2430mm
G-502-C	2960mm

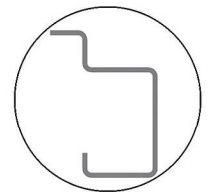

Vista da furação frontal

G-503

 Vigueta Superior da Tamba Inferior com Furação p/Presilha e Arco

COD.	MEDIDAS
G-503-A	2212mm
G-503-B	2430mm
G-503-C	2960mm



Vista da furação frontal

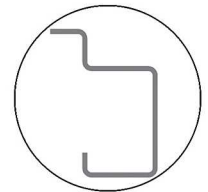

Vista da furação superior

G-505

 Vigueta Superior da Tamba Superior com Furação p/Presilha e Arco

COD.	MEDIDAS
G-505-A	2212mm
G-505-B	2430mm
G-505-C	2960mm



Vista da furação frontal



Vista da furação superior

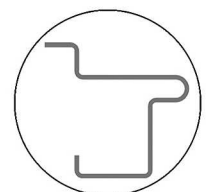

VIGUETAS - TAMPA DE POLIPROPILENO
G-511

 Vigueta Superior da Tampa Inferior com Furação p/Presilha

COD.	MEDIDAS
G-511-A	2212mm
G-511-B	2430mm
G-511-C	2965mm

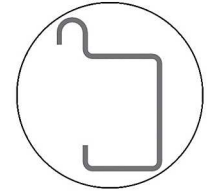

Vista da furação frontal

G-512

 Vigueta Superior da Tampa Inferior com Furação p/Presilha e Arco

COD.	MEDIDAS
G-512-A	2212mm
G-512-B	2430mm
G-512-C	2965mm



Vista da furação frontal

Vista da furação superior

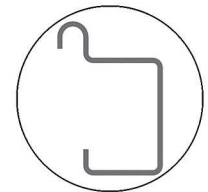
G-514

 Vigueta Superior da Tampa Superior com Furação p/Presilha e Arco

COD.	MEDIDAS
G-514-A	2212mm
G-514-B	2430mm
G-514-C	2965mm



Vista da furação frontal

Vista da furação superior

G-518

 Vigueta Inferior Tampa Tecno 10 sem Furação (Tubo 30x50)

COD.	MEDIDAS
G-518-A	2212mm
G-518-B	2430mm
G-518-C	2965mm

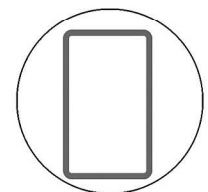
G-515-F

Suporte Vigueta da Tampa de Polipropileno LD (1000mm)

G-516-F

Suporte Vigueta da Tampa de Polipropileno LE (1000mm)



FUEIROS DA TAMPA

G-496

Fueiro da Tampa Inferior Moderna

COD.	MEDIDAS	ALT.TAMPA
G-496-A	447 mm	550 mm
G-496-B	497 mm	600 mm
G-496-C	547 mm	650 mm
G-496-D	597 mm	700 mm
G-496-E	697 mm	800 mm
G-496-F	897 mm	1000 mm
G-496-G	997 mm	1100 mm

G-494

Fueiro da Tampa Inferior c/Dobradiça

COD.	MEDIDAS	ALT.TAMPA
G-494-A	447 mm	550 mm
G-494-B	497 mm	600 mm
G-494-C	547 mm	650 mm
G-494-D	597 mm	700 mm
G-494-E	697 mm	800 mm
G-494-F	897 mm	1000 mm
G-494-G	997 mm	1100 mm

G-497

Fueiro da Tampa Superior

COD.	MEDIDAS	ALT.TAMPA
G-497-A	447 mm	550 mm
G-497-B	497 mm	600 mm
G-497-C	547 mm	650 mm
G-497-D	597 mm	700 mm
G-497-E	697 mm	800 mm
G-497-F	897 mm	1000 mm
G-497-G	997 mm	1100 mm

* Sob Encomenda

G-495

Fueiro da Tampa Superior c/Dobradiça

COD.	MEDIDAS	ALT.TAMPA
G-495-A	447 mm	550 mm
G-495-B	497 mm	600 mm
G-495-C	547 mm	650 mm
G-495-D	597 mm	700 mm
G-495-E	697 mm	800 mm
G-495-F	897 mm	1000 mm

* Sob Encomenda



G-441

Fueiro da Tampa Tecno 10 Moderna

COD.	MEDIDAS	ALT.TAMPA
G-441-A	438 mm	550 mm
G-441-B	488 mm	600 mm
G-441-C	538 mm	650 mm
G-441-D	588 mm	700 mm
G-441-E	688 mm	800 mm
G-441-F	888 mm	1000 mm

G-492

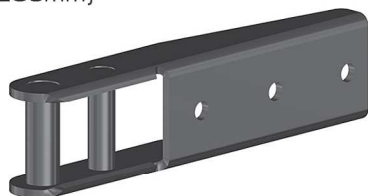
Dobradiça da Tampa Antiga
(209mm)



G-493

Dobradiça da Tampa Moderna
(174mm)

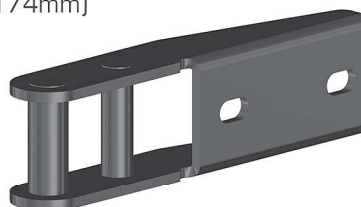

G-446

Dobradiça do Tombador Superior
(150mm)

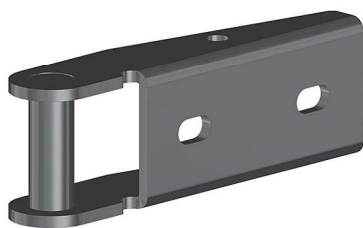

G-445

Dobradiça do Tombador Inferior
(150mm) chapa 4,25mm

G-445-A

Dobradiça do Tombador Inferior
(150mm) chapa 6,35mm

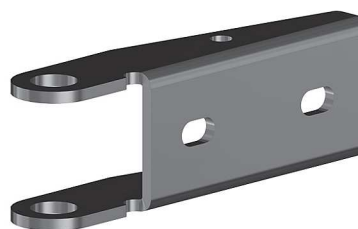

DOBRADIÇAS - TECNO 10

G-443

Dobradiça Traseira Inferior Tecno 10
(150mm)



G-444

Dobradiça Traseira Superior Tecno 10
(150mm)



G-442

Dobradiça Lateral Tecno 10
(174mm)

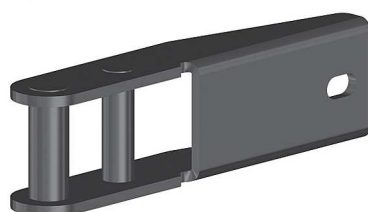

G-484

Gancho do Tombador



G-437

Caixa do Fueiro
estampado



G-438

Encaixe do Fueiro Superior

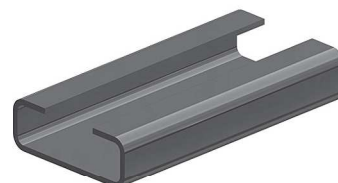

G-440

Engate Fêmea Inferior
Tecno 10

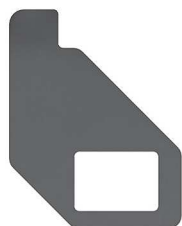

G-591

Engate Fêmea 2009

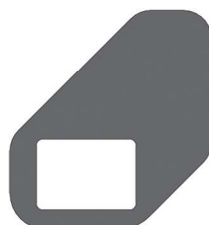

G-590

Engate Fêmea 2010

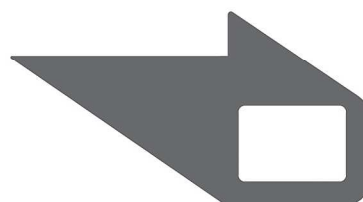

G-592

Engate Fêmea Inferior
Linha Garra 2016

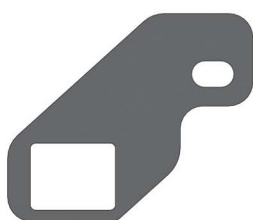

G-593

Engate Fêmea Superior
Linha Garra 2016

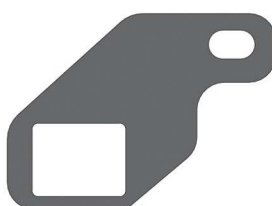

G-447

Engate Fêmea Inferior
Tampa Traseira Superior



G-481

Engate Fêmea Superior

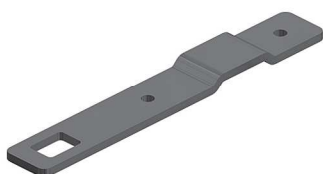

G-480

Engate Fêmea Inferior

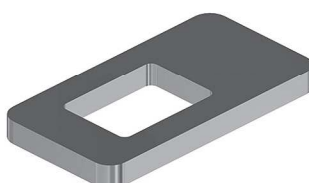

G-482

Engate Fêmea Fominha Moderno

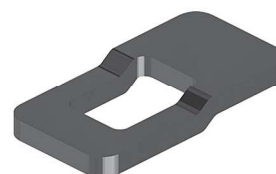

G-489

Perfil Dianteiro

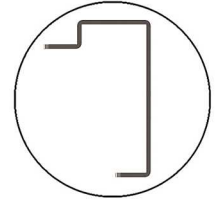

G-489-A

Perfil Dianteiro (Freio ABS)

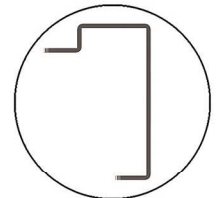

G-474

Cinta do Parabarro (696mm)

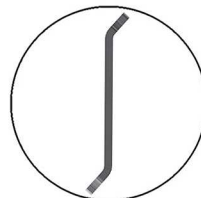

G-465

Suporte Central



COD.	MEDIDAS
G-465-A	810 mm
G-465-B	830 mm
G-465-C	860 mm

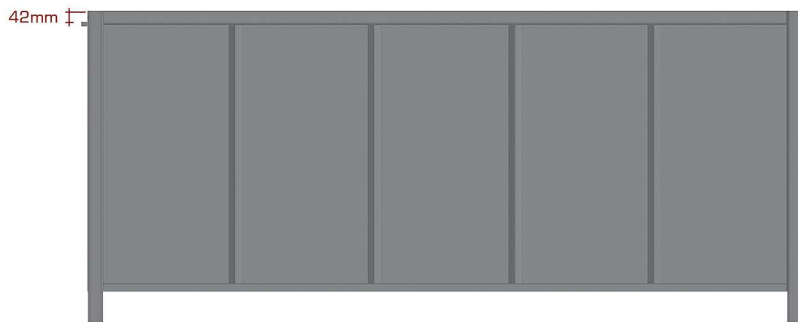

L-901
Batente Antigo

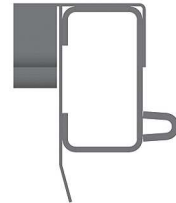

L-901

Frontal de Graneleira Inferior
Batente Antigo (c/Reforços Verticais)

COD.	MEDIDAS
L-901-A	550 mm
L-901-E	800 mm
L-901-G	900 mm
L-901-F	1000 mm

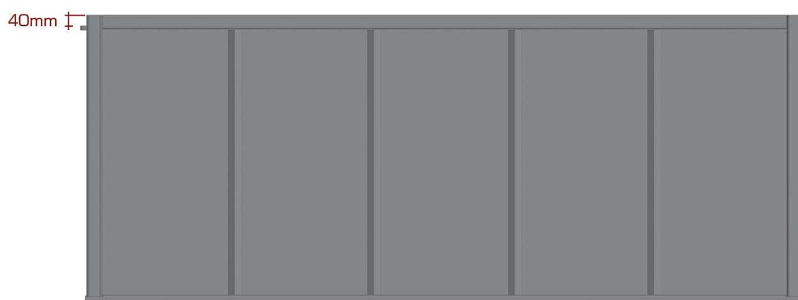

L-902
Batente Antigo

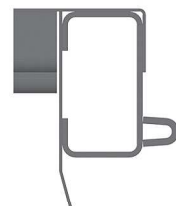

L-902

Frontal de Graneleira Superior
Batente Antigo (c/Reforços Verticais)

COD.	MEDIDAS
L-902-E	800 mm
L-902-G	900 mm
L-902-F	1000 mm

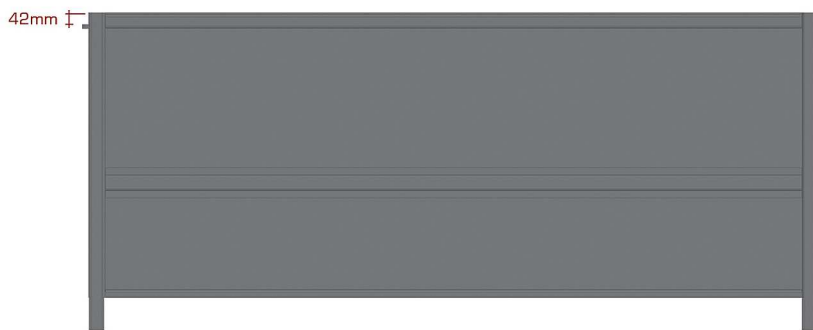

L-940

Frontal de Graneleira Inferior
2012 / 2013 (c/Reforço Horizontal)

COD.	MEDIDAS
L-940-A	550 mm
L-940-C	800 mm
L-940-D	900 mm
L-940-E	1000 mm

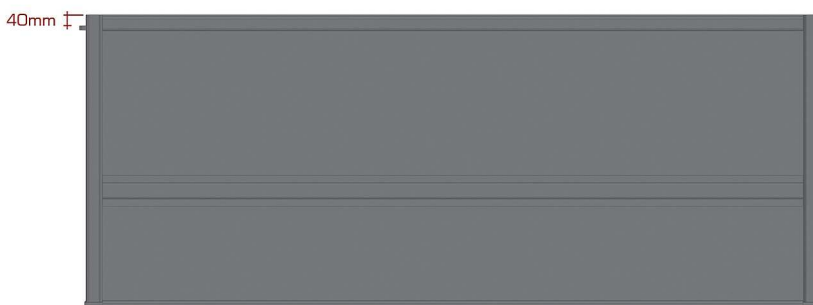

L-941

Frontal de Graneleira Superior
2012 / 2013 (c/Reforço Horizontal)

COD.	MEDIDAS
L-941-C	800 mm
L-941-D	900 mm
L-941-E	1000 mm

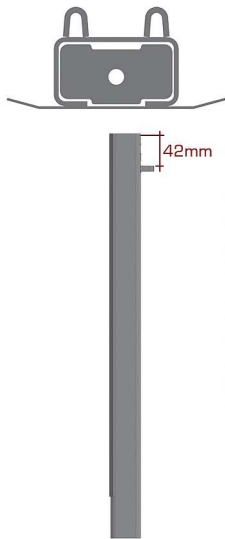
L-910

Fuego Lateral Inferior

COD.	MEDIDAS
L-910-A	550 mm
L-910-E	800 mm
L-910-G	900 mm
L-910-F	1000 mm

* Compatível com L-942

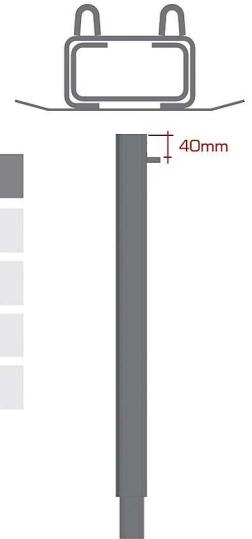
L-911

Fuego Lateral Superior

COD.	MEDIDAS
L-911-E	800 mm
L-911-G	900 mm
L-911-F	1000 mm

* Compatível com L-943

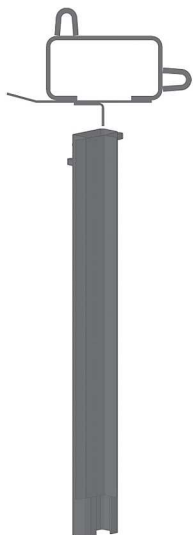
L-912

Fuego Canto Inferior Direito

COD.	MEDIDAS
L-912-A	550 mm
L-912-E	800 mm
L-912-G	900 mm
L-912-F	1000 mm

* Compatível com L-942

L-913

Fuego Canto Inferior Esquerdo

COD.	MEDIDAS
L-913-A	550 mm
L-913-E	800 mm
L-913-G	900 mm
L-913-F	1000 mm

* Compatível com L-942

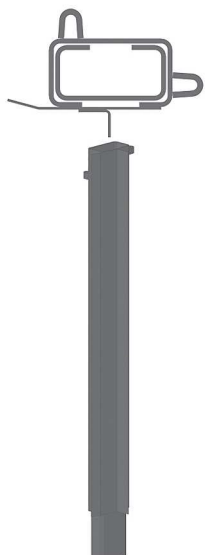
L-914

Fuego Canto Superior Direito

COD.	MEDIDAS
L-914-A	550 mm
L-914-E	800 mm
L-914-G	900 mm
L-914-F	1000 mm

* Compatível com L-943

L-915

Fuego Canto Superior Esquerdo

COD.	MEDIDAS
L-915-A	550 mm
L-915-E	800 mm
L-915-G	900 mm
L-915-F	1000 mm

* Compatível com L-943

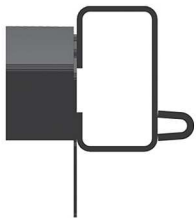
L-991

Frontal Inferior Horizon

COD.	MEDIDAS
L-991-A	800 mm
L-991-B	900 mm
L-991-C	1000 mm

L-992

Frontal Superior Horizon

COD.	MEDIDAS
L-992-A	800 mm
L-992-B	900 mm
L-992-C	1000 mm

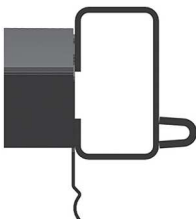
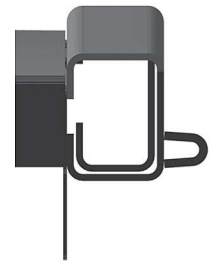
L-1000

Frontal Inferior Eco+

COD.	MEDIDAS
L-1000-A	800 mm
L-1000-B	900 mm
L-1000-C	1000 mm

Estampado

L-1001

Frontal Superior Eco+

COD.	MEDIDAS
L-1001-A	800 mm
L-1001-B	900 mm
L-1001-C	1000 mm

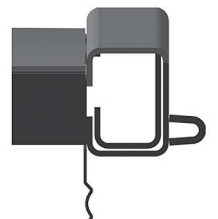

Estampado

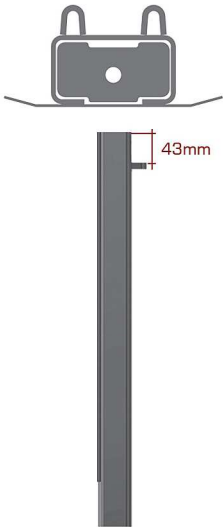
L-960

Fuego Lateral Inferior

COD.	MEDIDAS
L-960-A	550 mm
L-960-B	600 mm
L-960-C	650 mm
L-960-D	700 mm
L-960-E	800 mm
L-960-F	900 mm
L-960-G	1000 mm

* Compatível com L-1012

L-961

Fuego Lateral Superior

COD.	MEDIDAS
L-961-A	550 mm
L-961-B	600 mm
L-961-C	650 mm
L-961-D	700 mm
L-961-E	800 mm
L-961-F	900 mm
L-961-G	1000 mm

* Compatível com L-1013

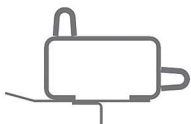
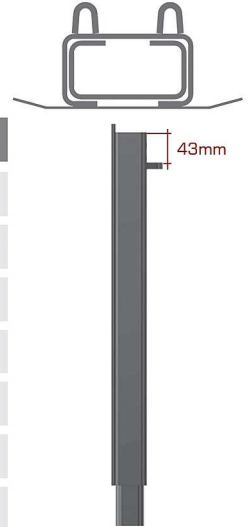
L-962

Fuego Canto Inferior Direito

COD.	MEDIDAS
L-962-A	550 mm
L-962-B	600 mm
L-962-C	650 mm
L-962-D	700 mm
L-962-E	800 mm
L-962-F	900 mm
L-962-G	1000 mm

* Compatível com L-1012

L-963

Fuego Canto Inferior Esquerdo

COD.	MEDIDAS
L-963-A	550 mm
L-963-B	600 mm
L-963-C	650 mm
L-963-D	700 mm
L-963-E	800 mm
L-963-F	900 mm
L-963-G	1000 mm

* Compatível com L-1012

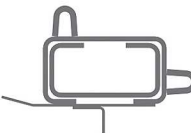
L-964

Fuego Canto Superior Direito

COD.	MEDIDAS
L-964-A	550 mm
L-964-B	600 mm
L-964-C	650 mm
L-964-D	700 mm
L-964-E	800 mm
L-964-F	900 mm
L-964-G	1000 mm

* Compatível com L-1013

L-965

Fuego Canto Superior Esquerdo

COD.	MEDIDAS
L-965-A	550 mm
L-965-B	600 mm
L-965-C	650 mm
L-965-D	700 mm
L-965-E	800 mm
L-965-F	900 mm
L-965-G	1000 mm

* Compatível com L-1013

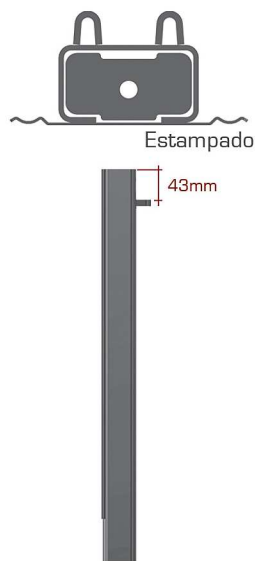
L-1002
 Fuego Lateral Inferior

COD.	MEDIDAS
L-1002-A	800 mm
L-1002-B	900 mm
L-1002-C	1000 mm

* Compatível com L-1008

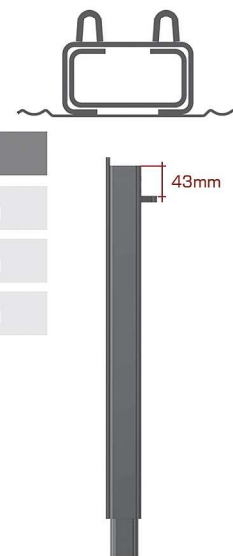
L-1003
 Fuego Lateral Superior

COD.	MEDIDAS
L-1003-A	800 mm
L-1003-B	900 mm
L-1003-C	1000 mm

* Compatível com L-1009

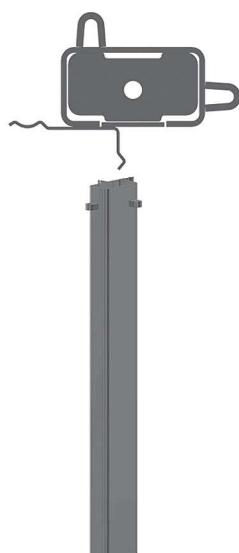
L-1004
 Fuego Canto Inferior Direito

COD.	MEDIDAS
L-1004-A	800 mm
L-1004-B	900 mm
L-1004-C	1000 mm

* Compatível com L-1008

L-1005
 Fuego Canto Inferior Esquerdo

COD.	MEDIDAS
L-1005-A	800 mm
L-1005-B	900 mm
L-1005-C	1000 mm

* Compatível com L-1008

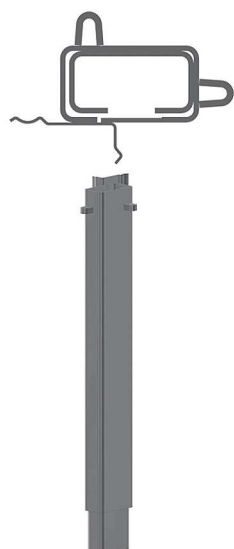
L-1006
 Fuego Canto Superior Direito

COD.	MEDIDAS
L-1006-A	800 mm
L-1006-B	900 mm
L-1006-C	1000 mm

* Compatível com L-1009

L-1007
 Fuego Canto Superior Esquerdo

COD.	MEDIDAS
L-1007-A	800 mm
L-1007-B	900 mm
L-1007-C	1000 mm

* Compatível com L-1009

L-942

Ferragem Tampa Lateral Inferior

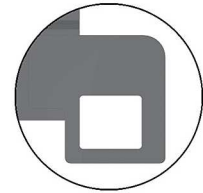
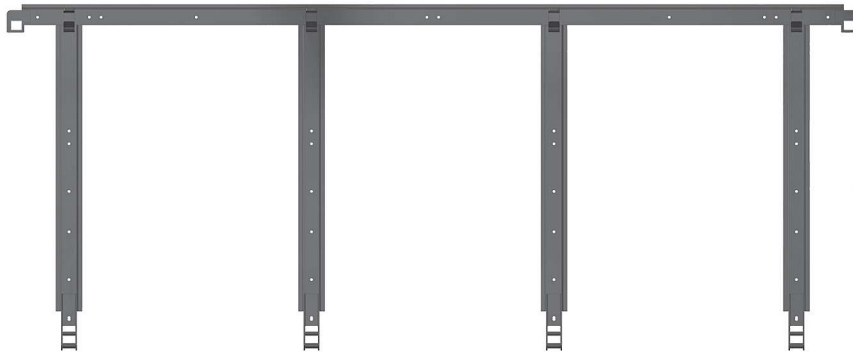
 Fueiro compatível:
 Altura da Presilha 42mm

COD.	MEDIDAS	COD.	MEDIDAS	COD.	MEDIDAS
L-942-B	800 x 2230mm	L-942-F	800 x 2590mm	L-942-J	800 x 2970mm
L-942-C	900 x 2230mm	L-942-G	900 x 2590mm	L-942-K	900 x 2970mm
L-942-D	1000 x 2230mm	L-942-H	1000 x 2590mm	L-942-L	1000 x 2970mm
Ferragem Carga Seca					
		L-942-M	550 x 2970mm		

L-943

Ferragem Tampa Lateral Superior

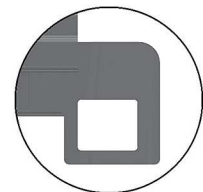
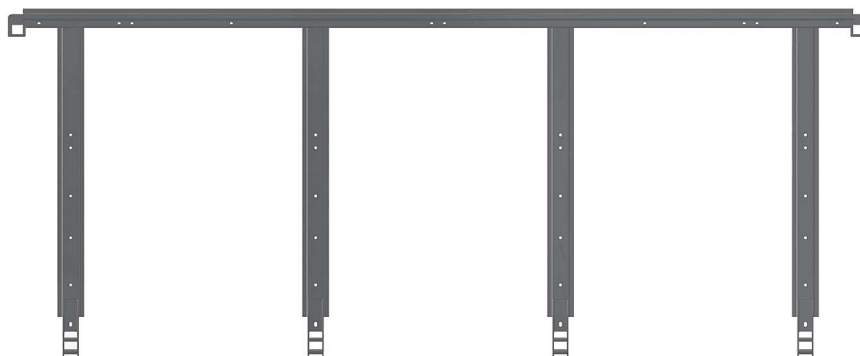
 Fueiro compatível:
 Altura da Presilha 40mm

COD.	MEDIDAS	COD.	MEDIDAS	COD.	MEDIDAS
L-943-B	800 x 2230mm	L-943-F	800 x 2590mm	L-943-J	800 x 2970mm
L-943-C	900 x 2230mm	L-943-G	900 x 2590mm	L-943-K	900 x 2970mm
L-943-D	1000 x 2230mm	L-943-H	1000 x 2590mm	L-943-L	1000 x 2970mm

L-944

Ferragem Tampa Traseira Inferior
(com Tombador)

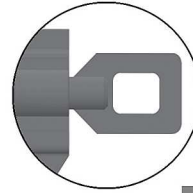

Fueiro compatível:
Altura da Presilha 10mm

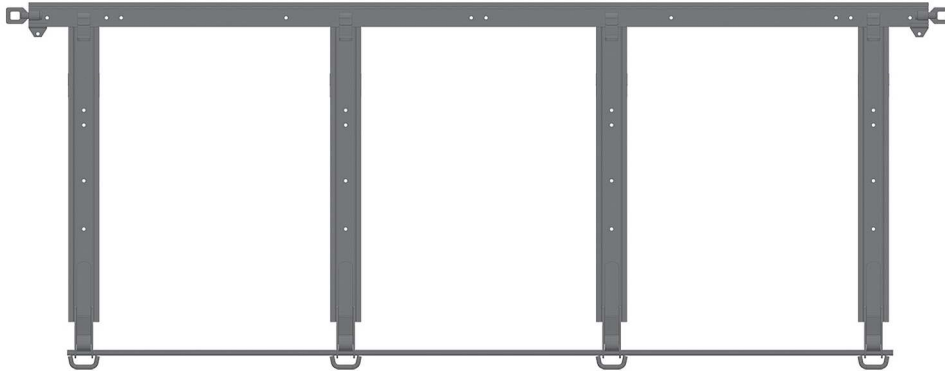

COD.	MEDIDAS
L-944-C	800 x 2420mm
L-944-D	900 x 2420mm
L-944-E	1000 x 2420mm
Ferragem Carga Seca	
L-944-A	550 x 2420mm

L-946

Conjunto do Tombador



L-945

Ferragem Tampa Traseira Superior

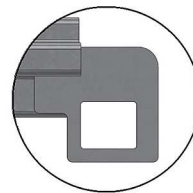

Fueiro compatível:
Altura da Presilha 40mm

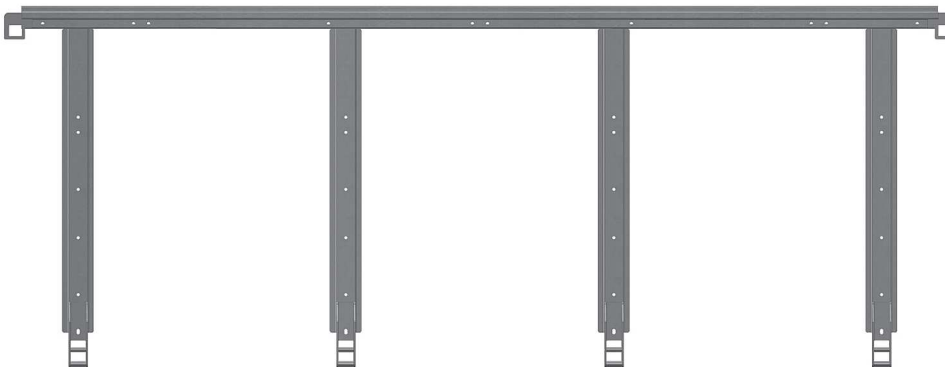

COD.	MEDIDAS
L-945-B	800 x 2420mm
L-945-C	900 x 2420mm
L-945-D	1000 x 2420mm

L-1012

Ferragem Lateral Inferior

Fueiro compatível:

Altura da Presilha 42mm



COD.	MEDIDAS
L-1012-A	800 x 2230mm
L-1012-B	800 x 2430mm
L-1012-C	800 x 2970mm

COD.	MEDIDAS
L-1012-D	900 x 2230mm
L-1012-E	900 x 2430mm
L-1012-F	900 x 2970mm

COD.	MEDIDAS
L-1012-G	1000 x 2230mm
L-1012-H	1000 x 2430mm
L-1012-I	1000 x 2970mm

L-1013

Ferragem Lateral Superior

Fueiro compatível:

Altura da Presilha 42mm



COD.	MEDIDAS
L-1013-A	800 x 2230mm
L-1013-B	800 x 2430mm
L-1013-C	800 x 2970mm

COD.	MEDIDAS
L-1013-D	900 x 2230mm
L-1013-E	900 x 2430mm
L-1013-F	900 x 2970mm

COD.	MEDIDAS
L-1013-G	1000 x 2230mm
L-1013-H	1000 x 2430mm
L-1013-I	1000 x 2970mm

L-1014

Ferragem Traseira Inferior
(com Tombador)



Fueiro compatível:
Altura da Presilha 42mm

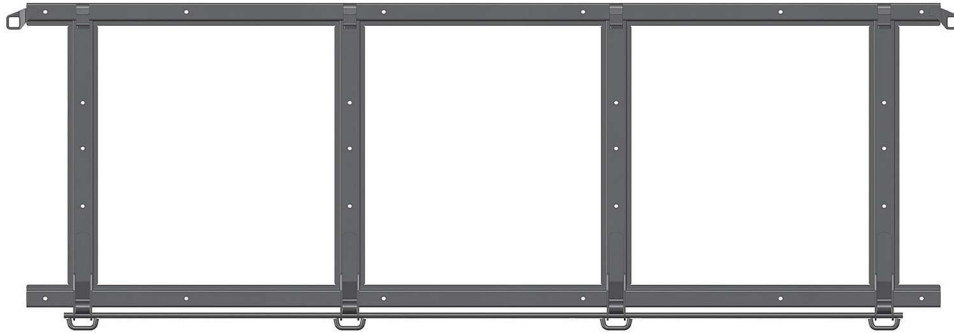

Tombador L-946

COD.	MEDIDAS
L-1014-A	800 x 2430mm
L-1014-B	900 x 2430mm
L-1014-C	1000 x 2430mm

L-1015

Ferragem Traseira Superior

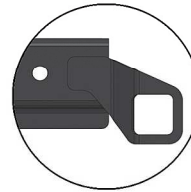

Fueiro compatível:
Altura da Presilha 42mm

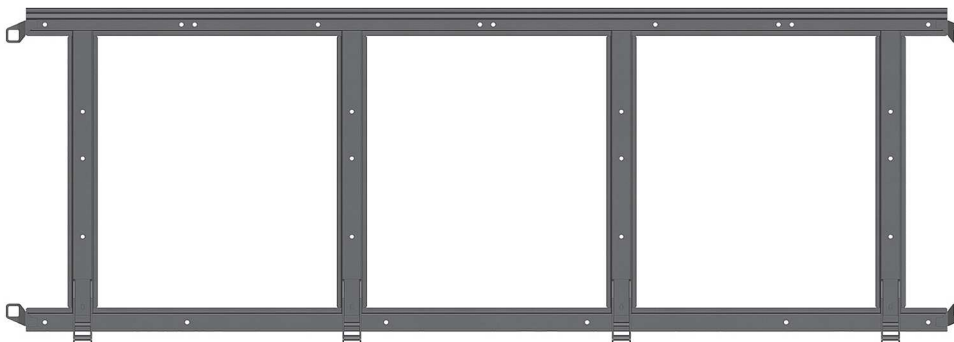

COD.	MEDIDAS
L-1015-A	800 x 2430mm
L-1015-B	900 x 2430mm
L-1015-C	1000 x 2430mm

L-1008

Ferragem Lateral Inferior

Fueiro compatível:

Altura da Presilha 43mm

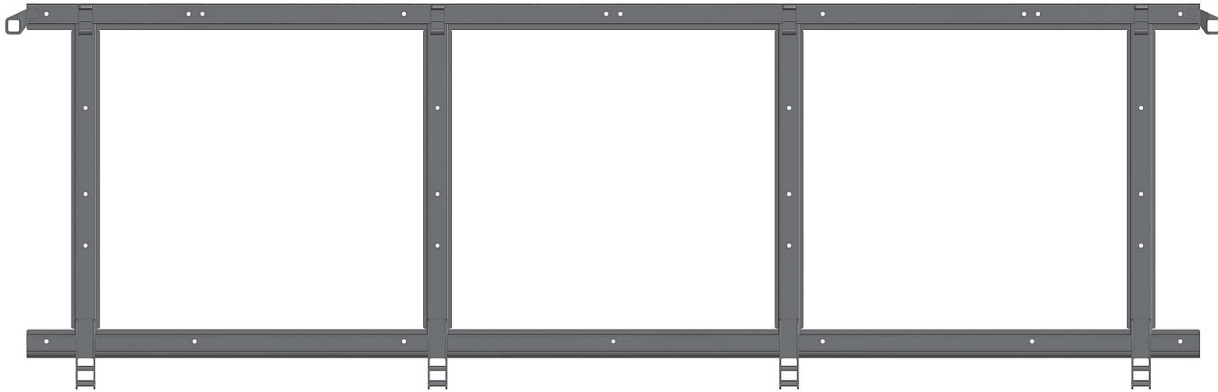

COD.	MEDIDAS
L-1008-A	800 x 2230mm
L-1008-B	800 x 2430mm
L-1008-C	800 x 2970mm

COD.	MEDIDAS
L-1008-D	900 x 2230mm
L-1008-E	900 x 2430mm
L-1008-F	900 x 2970mm

COD.	MEDIDAS
L-1008-G	1000 x 2230mm
L-1008-H	1000 x 2430mm
L-1008-I	1000 x 2970mm

L-1009

Ferragem Lateral Superior

Fueiro compatível:

Altura da Presilha 43mm

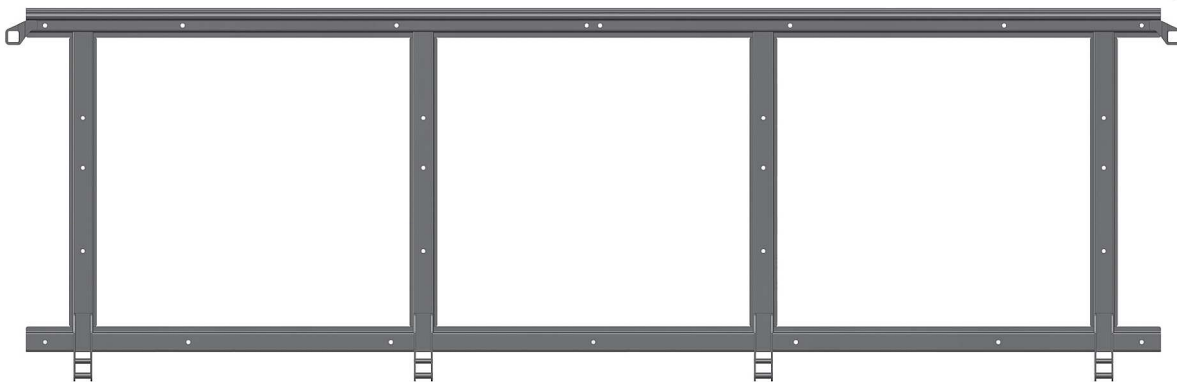

COD.	MEDIDAS
L-1009-A	800 x 2230mm
L-1009-B	800 x 2430mm
L-1009-C	800 x 2970mm

COD.	MEDIDAS
L-1009-D	900 x 2230mm
L-1009-E	900 x 2430mm
L-1009-F	900 x 2970mm

COD.	MEDIDAS
L-1009-G	1000 x 2230mm
L-1009-H	1000 x 2430mm
L-1009-I	1000 x 2970mm

L-1010

Ferragem Traseira Inferior
(com Tombador)

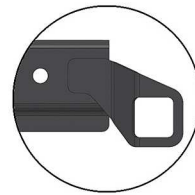

Fueiro compatível:
Altura da Presilha 43mm

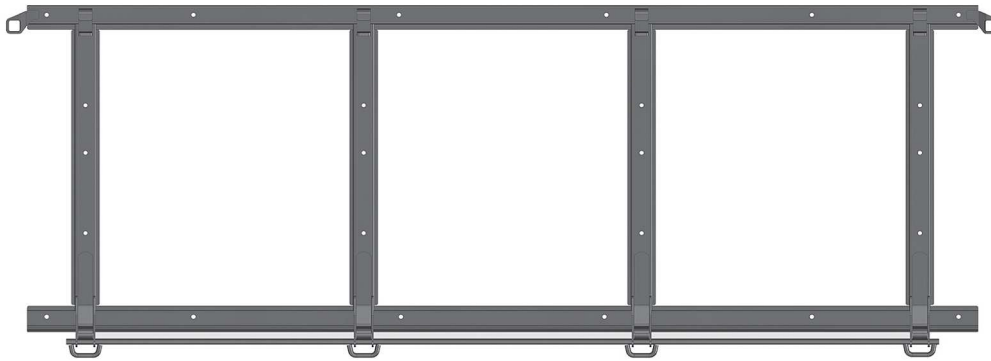

Tombador L-946

COD.	MEDIDAS
L-1010-A	800 x 2430mm
L-1010-B	900 x 2430mm
L-1010-C	1000 x 2430mm

L-1011

Ferragem Traseira Superior

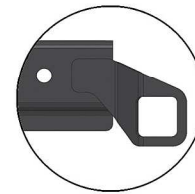

Fueiro compatível:
Altura da Presilha 43mm

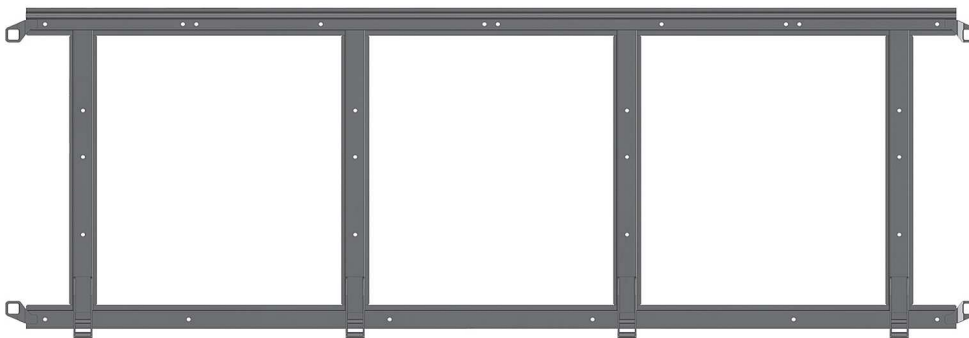

COD.	MEDIDAS
L-1011-A	800 x 2430mm
L-1011-B	900 x 2430mm
L-1011-C	1000 x 2430mm

L-922

Vigueta Superior da Tampa Inferior

COD.	MEDIDAS
L-922-A	2230mm
L-922-B	2420mm
L-922-C	2590mm
L-922-D	2970mm

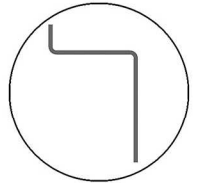

L-923

Vigueta Superior da Tampa Superior

COD.	MEDIDAS
L-923-A	2230mm
L-923-B	2420mm
L-923-C	2590mm
L-923-D	2970mm

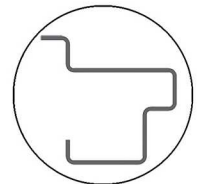

Vista da furação frontal



Vista da furação superior



L-994

Vigueta Inferior da Tampa Inferior e Superior
 Horizon
 Vigueta Inferior da Tampa Superior
 Eco +

COD.	MEDIDAS
L-994-A	2230 mm
L-994-B	2430 mm
L-994-C	2970 mm

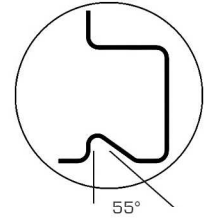
L-995

Vigueta Superior da Tampa Inferior
 Horizon / Eco +

COD.	MEDIDAS
L-995-A	2230 mm
L-995-B	2430 mm
L-995-C	2970 mm
L-995-T	2430 mm (tras)

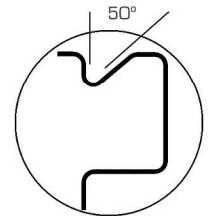
L-996

Vigueta Superior da Tampa Superior
 Horizon / Eco +

COD.	MEDIDAS
L-996-A	2230 mm
L-996-B	2430 mm
L-996-C	2970 mm
L-996-T	2430 mm (tras)

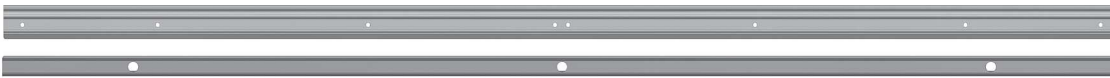

Vista da furação frontal

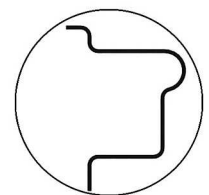

Vista da furação superior

L-999

Vigueta Inferior da Tampa Inferior
 Eco+

COD.	MEDIDAS
L-999-A	2230 mm
L-999-B	2430 mm
L-999-C	2970 mm

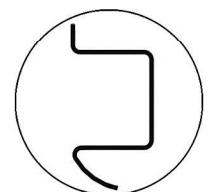

FUEIROS DA TAMPA

L-935

Fueiro da Tampa com Dobradiça

COD.	MEDIDAS
L-935-A	453 mm
L-935-E	703 mm
L-935-F	803 mm
L-935-G	903 mm

L-934

Fueiro da Tampa

COD.	MEDIDAS
L-934-A	453 mm
L-934-E	703 mm
L-934-F	803 mm
L-934-G	903 mm

FUEIROS DA TAMPA - HORIZON / ECO+

L-997

Fueiro da Tampa Linha Horizon

COD.	MEDIDAS
L-997-A	697 mm
L-997-B	797 mm
L-997-C	897 mm



L-998

Fueiro da Tampa Linha Eco+

COD.	MEDIDAS
L-998-A	687 mm
L-998-B	787 mm
L-998-C	887 mm

L-950

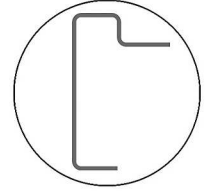
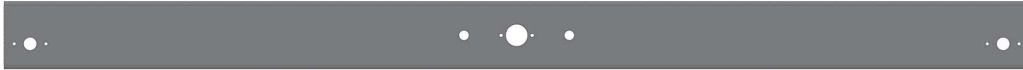
Perfil Dianteiro (2420mm)



L-950-A

Perfil Dianteiro Horizon

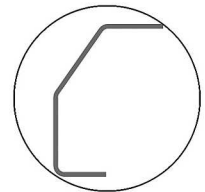

L-949

Perfil Traseiro Horizon

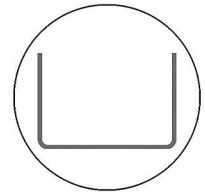

L-979

Tirante 6,35x55x1302mm



L-980

Suporte Identificação
de Risco Simples



L-981

Suporte Identificação
de Risco Duplo

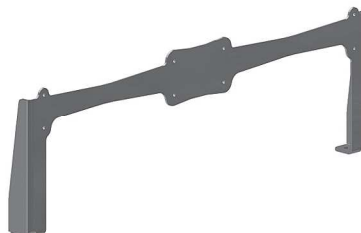

L-988

Suporte Placas
de Identificação



L-976

Perfil Proteção Suspensor Tanque

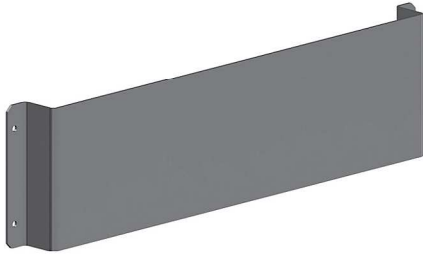

L-971

Suporte Plaqueta de Identificação

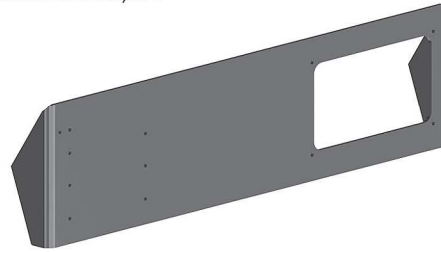

L-989

Suporte Cone



L-990-A

Suporte Pé de Levantamento

L-990-B

Suporte Pé de Levantamento

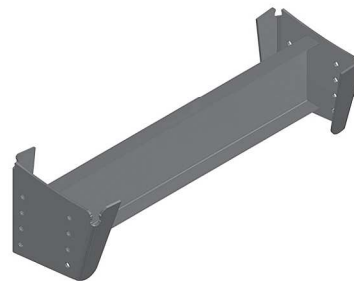

L-948

Degrau da Frontal

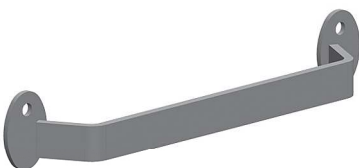

L-929

Cinta do Parabarro (590mm)

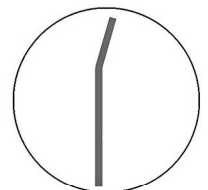

L-972

Suporte Reservatório de Ar



L-973

Suporte Reservatório de Ar
Vanderleia Tanque

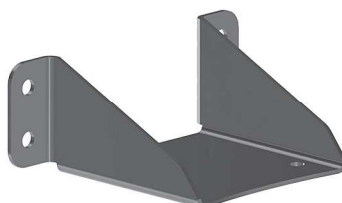

L-984

Reforço Cj. Amarração
de Carga

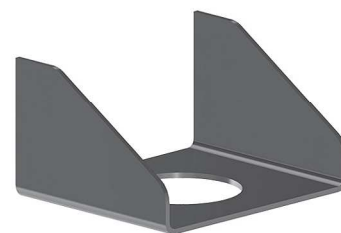

L-959-A

Reforço da Passante LD

L-959-B

Reforço da Passante LE



L-970

Suporte Válvula Cj. Chassi



L-969

Suporte Soquete Óptico



L-977

Suporte Reservatório de Água
382mm



L-978

Suporte Reservatório de Água
500mm



L-974

Reforço Rala Vanderleia



L-951

Dobradiça Lateral
(178mm)



L-952

Dobradiça do Tombador
Inferior (140mm)



L-953

Dobradiça do Tombador
Superior (140mm)



L-951-A

Dobradiça Lateral
Eco+ (178mm)

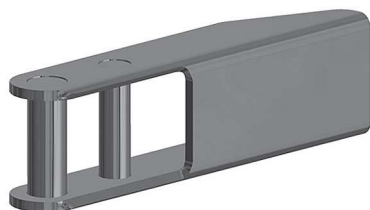

L-920

Caixa do Fueiro
(estampado)



L-921

Encaixe do Fueiro Superior



L-938

Engate Fêmea

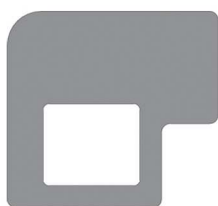

L-916

Reforço da Travessa Central
do Chassi

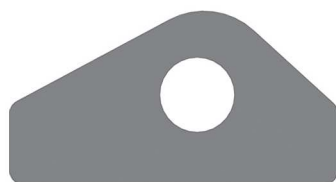

L-926

Aranha do Assoalho
(zincado)



L-955-A

Engate Fêmea Superior/Inferior LD (Horizon)

L-955-B

Engate Fêmea Superior/Inferior LE (Horizon)

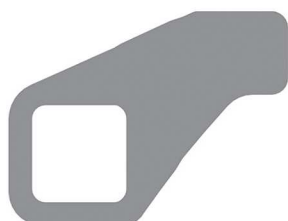

L-928

Engate "G"



FRONTAIS / largura 2548mm (carreta)

F-601
 Modelo
 99mm

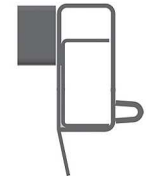
F-605
 Modelo Largo
 124mm

F-601

Frontal de Graneleira Inferior

COD.	MEDIDAS
F-601-A	550 mm
F-601-D	700 mm
F-601-E	800 mm
F-601-F	1000 mm

F-605

Frontal de Graneleira Inferior (Largo)

COD.	MEDIDAS
F-605-A	550 mm
F-605-D	700 mm
F-605-E	800 mm
F-605-F	1000 mm

F-602
 Modelo
 99mm

F-606
 Modelo Largo
 124mm

F-602

Frontal de Graneleira Superior

COD.	MEDIDAS
F-602-A	550 mm
F-602-D	700 mm
F-602-E	800 mm
F-602-F	1000 mm

F-606

Frontal de Graneleira Superior (Largo)

COD.	MEDIDAS
F-606-A	550 mm
F-606-D	700 mm
F-606-E	800 mm
F-606-F	1000 mm

FRONTAIS / largura 2555mm (bitrem)

F-601X
 Modelo
 99mm

F-605X
 Modelo Largo
 124mm

F-601X

Frontal de Graneleira Inferior

COD.	MEDIDAS
F-601-AX	550 mm
F-601-DX	700 mm
F-601-EX	800 mm
F-601-FX	1000 mm

F-605X

Frontal de Graneleira Inferior (Largo)

COD.	MEDIDAS
F-605-AX	550 mm
F-605-DX	700 mm
F-605-EX	800 mm
F-605-FX	1000 mm

F-602X
 Modelo
 99mm

F-606X
 Modelo Largo
 124mm

F-602X

Frontal de Graneleira Superior

COD.	MEDIDAS
F-602-AX	550 mm
F-602-DX	700 mm
F-602-EX	800 mm
F-602-FX	1000 mm

F-606X

Frontal de Graneleira Superior (Largo)

COD.	MEDIDAS
F-606-AX	550 mm
F-606-DX	700 mm
F-606-EX	800 mm
F-606-FX	1000 mm

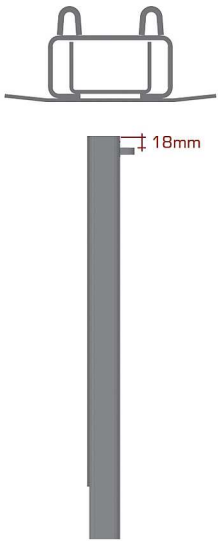

F-610
 Fueiro Lateral Inferior

COD.	MEDIDAS
F-610-A	550 mm
F-610-D	700 mm
F-610-E	800 mm
F-610-F	1000 mm

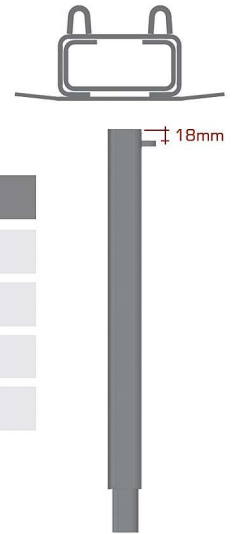

F-611
 Fueiro Lateral Superior

COD.	MEDIDAS
F-611-A	550 mm
F-611-D	700 mm
F-611-E	800 mm
F-611-F	1000 mm

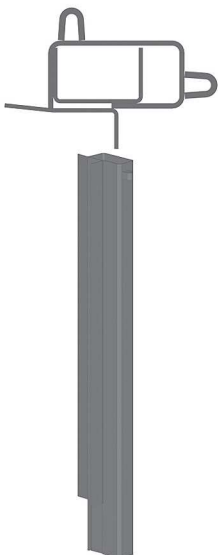

F-613
 Fueiro Canto Inferior Direito

COD.	MEDIDAS
F-613-A	550 mm
F-613-D	700 mm
F-613-E	800 mm
F-613-F	1000 mm

F-614
 Fueiro Canto Inferior Esquerdo

COD.	MEDIDAS
F-614-A	550 mm
F-614-D	700 mm
F-614-E	800 mm
F-614-F	1000 mm

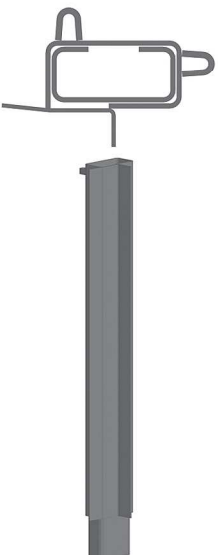

F-615
 Fueiro Canto Superior Direito

COD.	MEDIDAS
F-615-A	550 mm
F-615-D	700 mm
F-615-E	800 mm
F-615-F	1000 mm

F-616
 Fueiro Canto Superior Esquerdo

COD.	MEDIDAS
F-616-A	550 mm
F-616-D	700 mm
F-616-E	800 mm
F-616-F	1000 mm

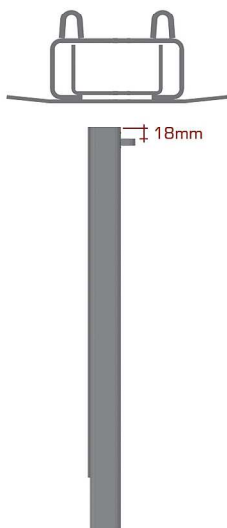

F-621
Fuego Lateral Inferior

COD.	MEDIDAS
F-621-A	550 mm
F-621-D	700 mm
F-621-E	800 mm
F-621-F	1000 mm

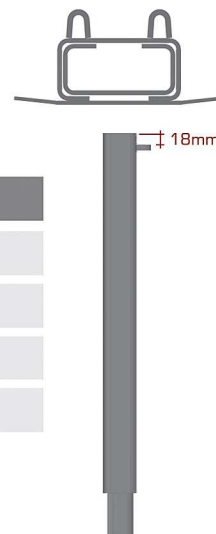

F-622
Fuego Lateral Superior

COD.	MEDIDAS
F-622-A	550 mm
F-622-D	700 mm
F-622-E	800 mm
F-622-F	1000 mm

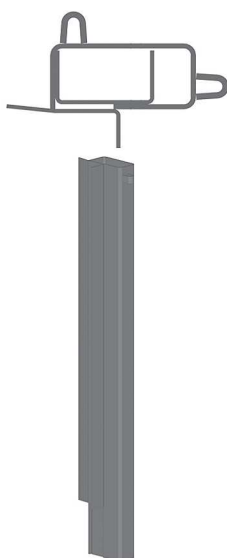

F-624
Fuego Canto Inferior Direito

COD.	MEDIDAS
F-624-A	550 mm
F-624-D	700 mm
F-624-E	800 mm
F-624-F	1000 mm

F-625
Fuego Canto Inferior Esquerdo

COD.	MEDIDAS
F-625-A	550 mm
F-625-D	700 mm
F-625-E	800 mm
F-625-F	1000 mm

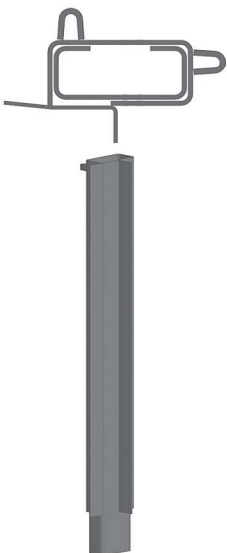

F-626
Fuego Canto Superior Direito

COD.	MEDIDAS
F-626-A	550 mm
F-626-D	700 mm
F-626-E	800 mm
F-626-F	1000 mm

F-627
Fuego Canto Superior Esquerdo

COD.	MEDIDAS
F-627-A	550 mm
F-627-D	700 mm
F-627-E	800 mm
F-627-F	1000 mm

LATERAL / PERFIL / FUEIRO

F-655

Lateral da Carreta 3000mm

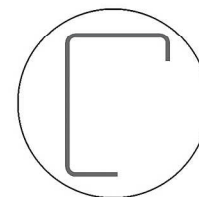

F-656

Perfil Dianteiro 2435mm

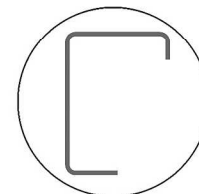

VIGUETAS - ATÉ 2016

F-662

Viguetas Inferior da Tampa Inferior e Superior
Sem Furação

COD.	MEDIDAS
F-662-C	2960mm

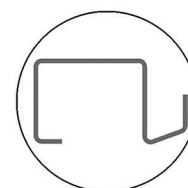

F-665

Viguetas Superior da Tampa Inferior
Sem Furação

COD.	MEDIDAS
F-665-C	2960mm

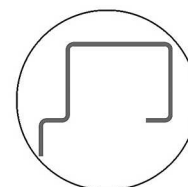

FUEIRO DA TAMPA

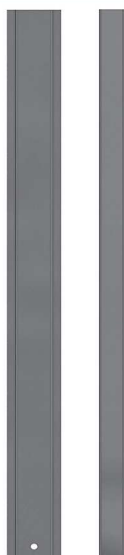

F-680

Fueiro da Tampa
Inferior / Superior

COD.	MEDIDAS	ALT. TAMPA
F-680-A	440 mm	550 mm
F-680-D	590 mm	700 mm
F-680-E	690 mm	800 mm
F-680-F	890 mm	1000 mm

F-696

Dobradiça Tampa Lateral
(184mm)

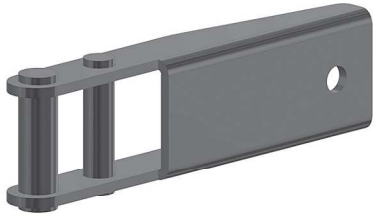

F-697

Dobradiça Tampa Traseira
(182mm)

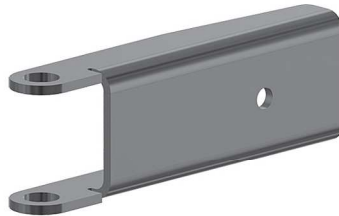

F-705

Dobradiça Tampa Traseira Superior 2020
(182mm)



F-702

Engate Fêmea Superior
(158mm)



F-604

Engate Fêmea Superior
(205mm)

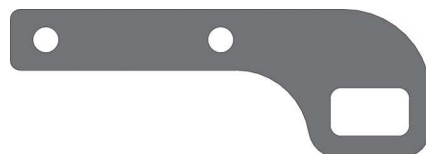

F-685

Engate Fêmea da Tampa
(205mm)



F-619

Caixa do Fueiro
(99mm)

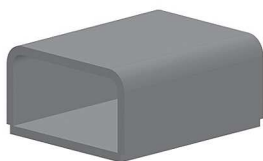

F-620

Encaixe do Fueiro Superior

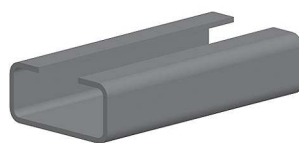

F-630

Caixa do Fueiro
(124mm)

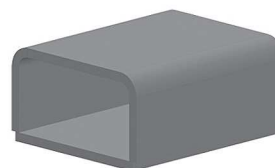

F-631

Encaixe do Fueiro Superior

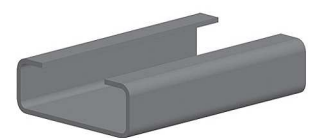

F-699

Alavanca Tombador
(325mm)

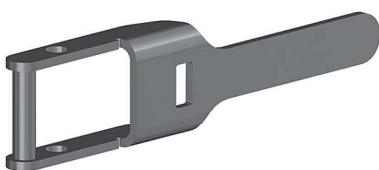

F-701

Conjunto do Tombador
* observar medida do varão



COD.	DESCRIÇÃO
F-701	Conjunto Tombador (varão 2170mm p/Ferragens c/Engate F-604)
F-701-A	Conjunto Tombador (varão 2260mm p/Ferragens c/Engate F-702)

FRONTAIS - BATENTE ANTIGO / ÁQUILA

 18mm (N-501)
 76mm (N-560)

N-501
 Batente Antigo

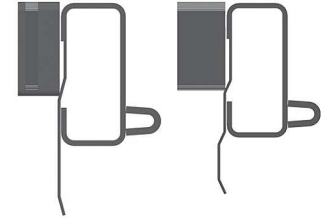
N-560
 Áquila

N-501

 Frontal de Graneleira Inferior
 Batente Antigo

COD.	MEDIDAS
N-501-A	550 mm
N-501-D	700 mm
N-501-E	800 mm
N-501-F	1000 mm

N-560

 Frontal de Graneleira Inferior
 Áquila

COD.	MEDIDAS
N-560-A	550 mm
N-560-D	700 mm
N-560-E	800 mm
N-560-F	1000 mm

 18mm (N-502)
 86mm (N-561)

N-502
 Batente Antigo

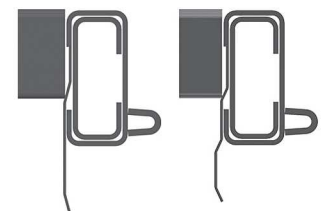
N-561
 Áquila

N-502

 Frontal de Graneleira Superior
 Batente Antigo

COD.	MEDIDAS
N-502-A	550 mm
N-502-D	700 mm
N-502-E	800 mm
N-502-F	1000 mm

N-561

 Frontal de Graneleira Superior
 Áquila

COD.	MEDIDAS
N-561-A	550 mm
N-561-D	700 mm
N-561-E	800 mm
N-561-F	1000 mm

FUEIROS - MODELO ANTIGO / largura 97mm

* Fueiros não compatíveis com as ferragens fornecidas pela Rovali.



18mm

N-510

Fueiro Lateral Inferior

COD.	MEDIDAS
N-510-A	550 mm
N-510-D	700 mm
N-510-E	800 mm
N-510-F	1000 mm

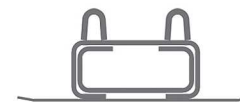

18mm

N-511

Fueiro Lateral Superior

COD.	MEDIDAS
N-511-A	550 mm
N-511-D	700 mm
N-511-E	800 mm
N-511-F	1000 mm

N-513

Fueiro Canto Inferior Direito

COD.	MEDIDAS
N-513-A	550 mm
N-513-D	700 mm
N-513-E	800 mm
N-513-F	1000 mm

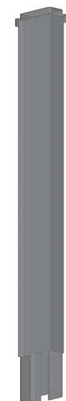
N-514

Fueiro Canto Inferior Esquerdo

COD.	MEDIDAS
N-514-A	550 mm
N-514-D	700 mm
N-514-E	800 mm
N-514-F	1000 mm

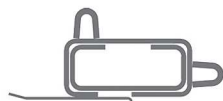
N-515

Fueiro Canto Superior Direito

COD.	MEDIDAS
N-515-A	550 mm
N-515-D	700 mm
N-515-E	800 mm
N-515-F	1000 mm

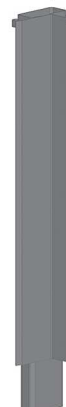
N-516

Fueiro Canto Superior Esquerdo

COD.	MEDIDAS
N-516-A	550 mm
N-516-D	700 mm
N-516-E	800 mm
N-516-F	1000 mm

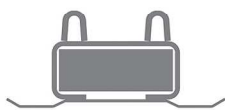

 76mm

N-570

Fueiro Lateral Inferior

COD.	MEDIDAS
N-570-A	550 mm
N-570-D	700 mm
N-570-E	800 mm
N-570-F	1000 mm

* Compatível com N-576

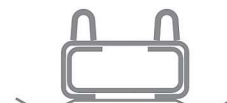

 86mm

N-571

Fueiro Lateral Superior

COD.	MEDIDAS
N-571-A	550 mm
N-571-D	700 mm
N-571-E	800 mm
N-571-F	1000 mm

* Compatível com N-577

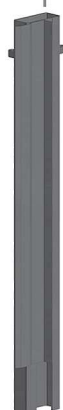
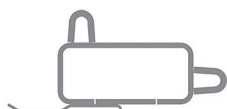

N-572

Fueiro Canto Inferior Direito

COD.	MEDIDAS
N-572-A	550 mm
N-572-D	700 mm
N-572-E	800 mm
N-572-F	1000 mm

* Compatível com N-576

N-573

Fueiro Canto Inferior Esquerdo

COD.	MEDIDAS
N-573-A	550 mm
N-573-D	700 mm
N-573-E	800 mm
N-573-F	1000 mm

* Compatível com N-576



N-574

Fueiro Canto Superior Direito

COD.	MEDIDAS
N-574-A	550 mm
N-574-D	700 mm
N-574-E	800 mm
N-574-F	1000 mm

* Compatível com N-577

N-575

Fueiro Canto Superior Esquerdo

COD.	MEDIDAS
N-575-A	550 mm
N-575-D	700 mm
N-575-E	800 mm
N-575-F	1000 mm

* Compatível com N-577

N-576

Ferragem Tampa Lateral Inferior

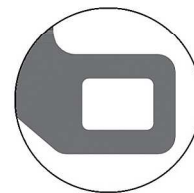
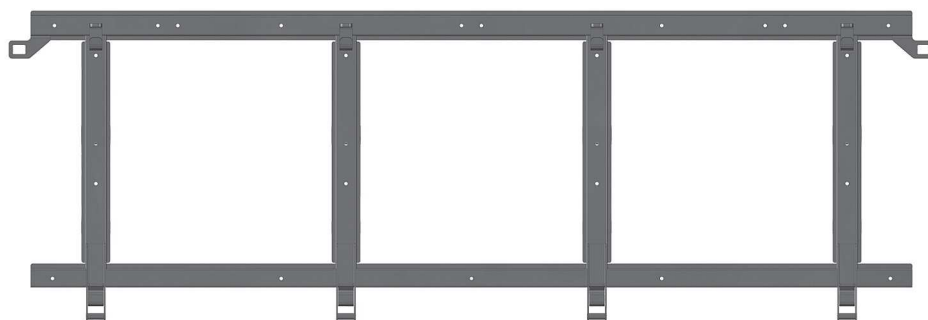
 Fueiro compatível:
 Altura da Presilha 76mm

COD.	MEDIDAS	COD.	MEDIDAS	COD.	MEDIDAS	COD.	MEDIDAS
N-576-A	550 x 2217mm	N-576-P	700 x 2217mm	N-576-U	800 x 2217mm	N-576-AA	1000 x 2217mm
N-576-B	550 x 2365mm	N-576-Q	700 x 2365mm	N-576-V	800 x 2365mm	N-576-AB	1000 x 2365mm
N-576-C	550 x 2565mm	N-576-R	700 x 2565mm	N-576-X	800 x 2565mm	N-576-AC	1000 x 2565mm
N-576-D	550 x 2865mm	N-576-S	700 x 2865mm	N-576-Y	800 x 2865mm	N-576-AD	1000 x 2865mm
N-576-E	550 x 3165mm	N-576-T	700 x 3165mm	N-576-Z	800 x 3165mm	N-576-AE	1000 x 3165mm

N-577

Ferragem Tampa Lateral Superior

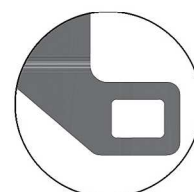
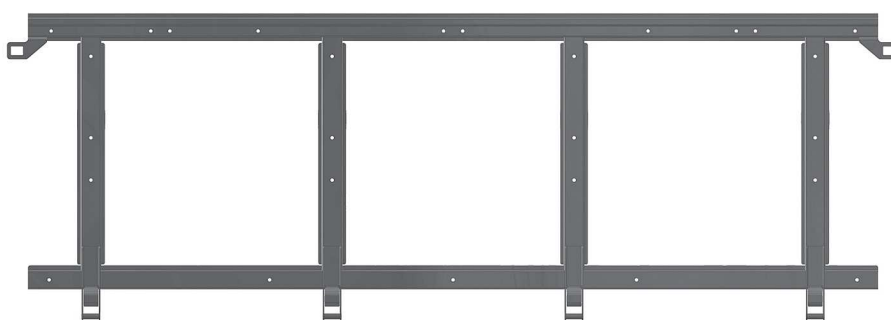
 Fueiro compatível:
 Altura da Presilha 86mm

COD.	MEDIDAS	COD.	MEDIDAS	COD.	MEDIDAS	COD.	MEDIDAS
N-577-A	550 x 2217mm	N-577-P	700 x 2217mm	N-577-U	800 x 2217mm	N-577-AA	1000 x 2217mm
N-577-B	550 x 2365mm	N-577-Q	700 x 2365mm	N-577-V	800 x 2365mm	N-577-AB	1000 x 2365mm
N-577-C	550 x 2565mm	N-577-R	700 x 2565mm	N-577-X	800 x 2565mm	N-577-AC	1000 x 2565mm
N-577-D	550 x 2865mm	N-577-S	700 x 2865mm	N-577-Y	800 x 2865mm	N-577-AD	1000 x 2865mm
N-577-E	550 x 3165mm	N-577-T	700 x 3165mm	N-577-Z	800 x 3165mm	N-577-AE	1000 x 3165mm

N-578

Ferragem Tampa Traseira Inferior
(com Tombador)

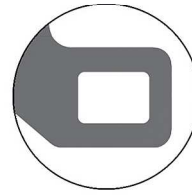

Fueiro compatível:
Altura da Presilha 76mm

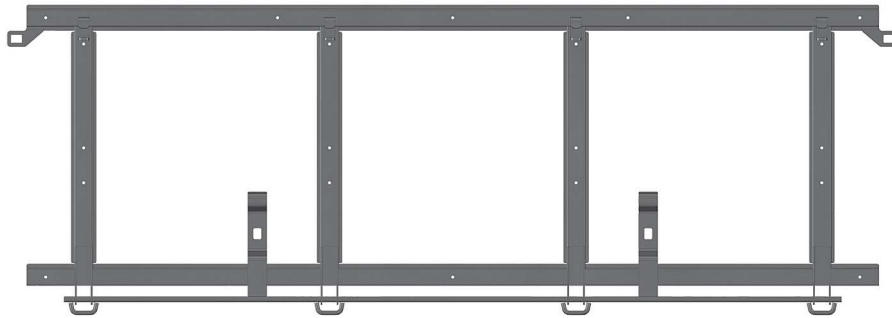

Tombador N-599

COD.	MEDIDAS
N-578-A	550 x 2445mm
N-578-D	700 x 2445mm
N-578-E	800 x 2445mm
N-578-F	1000 x 2445mm

N-579

Ferragem Tampa Traseira Superior

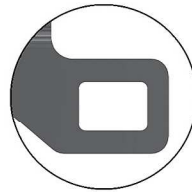

Fueiro compatível:
Altura da Presilha 86mm

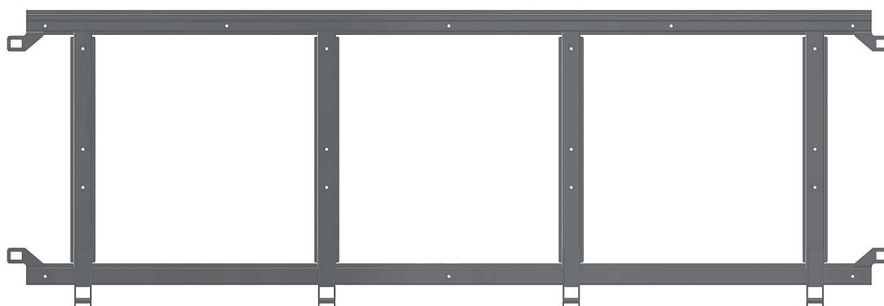

COD.	MEDIDAS
N-579-A	550 x 2445mm
N-579-D	700 x 2445mm
N-579-E	800 x 2445mm
N-579-F	1000 x 2445mm



N-552

Vigueta Inferior da Tapa Superior e Inferior
 Com Furação Lateral

COD.	MEDIDAS
N-552-A	2217 mm
N-552-B	2365 mm
N-552-C	2565 mm
N-552-D	2865 mm
N-552-E	3165 mm

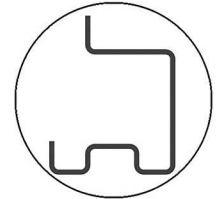
N-551

Vigueta Inferior da Tapa Superior e Inferior
 Com Furação Traseira

COD.	MEDIDAS
N-551-A	2445 mm

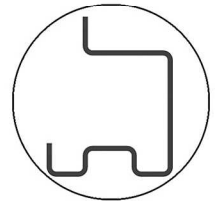
N-555

Vigueta Superior da Tapa Inferior
 Com Furação Lateral

COD.	MEDIDAS
N-555-A	2217 mm
N-555-B	2365 mm
N-555-C	2565 mm
N-555-D	2865 mm
N-555-E	3165 mm

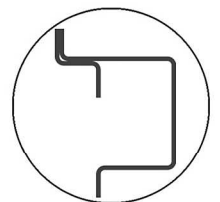
N-554

Vigueta Superior da Tapa Inferior
 Com Furação Traseira

COD.	MEDIDAS
N-554-A	2445 mm

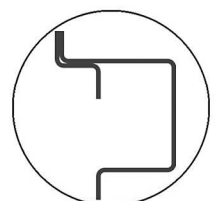

VIGUETAS - ÁQUILA
N-595

 Vigueta Superior da Tapa Superior
 Com Furação Lateral

COD.	MEDIDAS
N-595-A	2217 mm
N-595-B	2365 mm
N-595-E	2565 mm
N-595-D	2865 mm
N-595-F	3165 mm

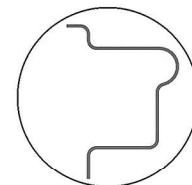

Vista de furação lateral



Vista de furação superior

N-595-T

 Vigueta Superior da Tapa Superior
 Com Furação Traseira

COD.	MEDIDAS
N-595-T	2445 mm

FUEIROS DA TAMPA - ÁQUILA
N-524

 Fueiro da Tapa Inferior
 Áquila

COD.	MEDIDAS	ALT. TAMPA
N-524-A	495 mm	550 mm
N-524-D	695 mm	700 mm
N-524-E	795 mm	800 mm
N-524-F	895 mm	1000 mm

N-525

 Fueiro da Tapa Superior
 Áquila

COD.	MEDIDAS	ALT. TAMPA
N-525-A	485 mm	550 mm
N-525-D	685 mm	700 mm
N-525-E	785 mm	800 mm
N-525-F	885 mm	1000 mm

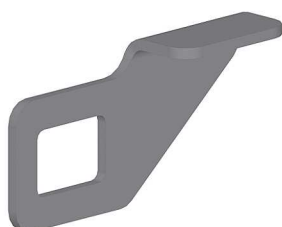
ENGATE FÊMEA- ÁQUILA

N-540-A

Engate Fêmea Áquila LD

N-540-B

Engate Fêmea Áquila LE

FRONTAIS - FÊNIX / largura 2548mm

ESTES PRODUTOS CONTÉM SOMENTE A FERRAGEM DO QUADRO.

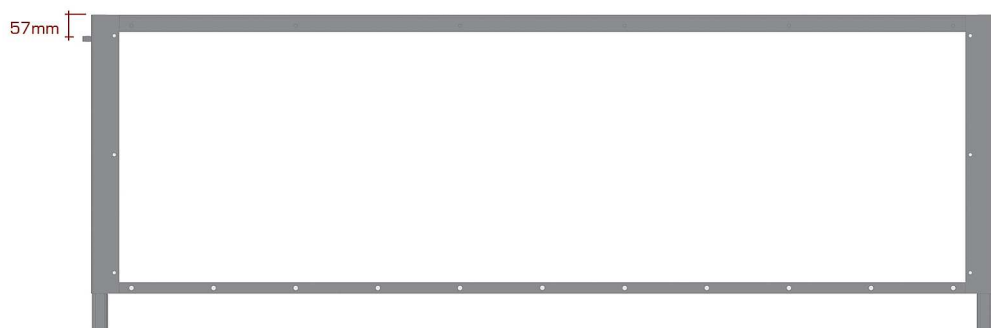
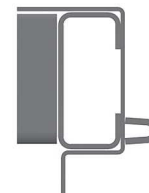
N-504
 Batente Reto

N-504

Frontal de Graneleira Inferior

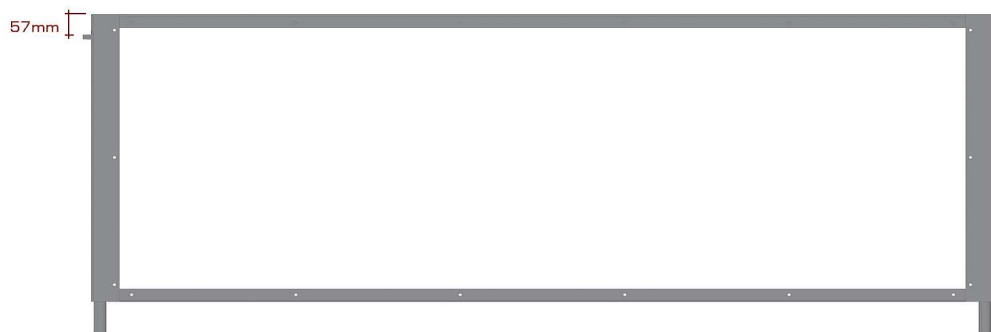
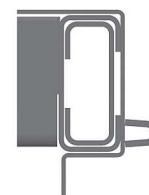
COD.	MEDIDAS
N-504-A	500 mm
N-504-B	640 mm
N-504-C	790 mm
N-504-D	990 mm

N-505
 Batente Reto

N-505

Frontal de Graneleira Superior

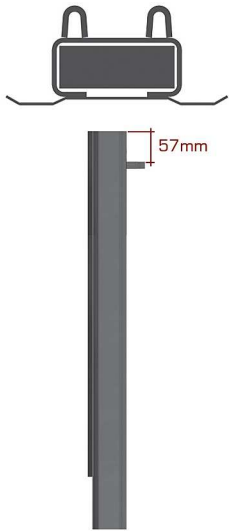
COD.	MEDIDAS
N-505-A	653 mm
N-505-B	803 mm
N-505-C	1003 mm

N-581

Fuego Lateral Inferior

COD.	MEDIDAS
N-581-A	500 mm
N-581-B	640 mm
N-581-C	790 mm
N-581-D	990 mm

* Compatível com N-587 / N-620

N-582

Fuego Lateral Superior

COD.	MEDIDAS
N-582-A	683 mm
N-582-B	803 mm
N-582-C	1003 mm

* Compatível com N-588 / N-621

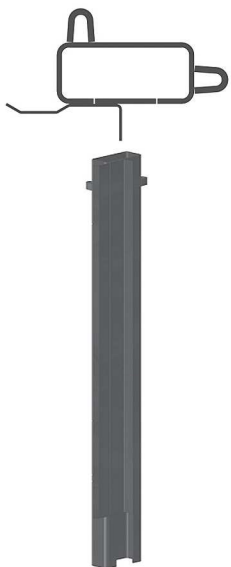
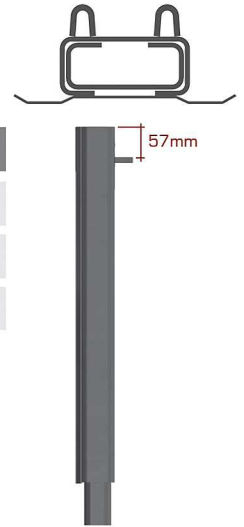
N-583

Fuego Canto Inferior Direito

COD.	MEDIDAS
N-583-A	500 mm
N-583-B	640 mm
N-583-C	790 mm
N-583-D	990 mm

* Compatível com N-587 / N-620

N-584

Fuego Canto Inferior Esquerdo

COD.	MEDIDAS
N-584-A	500 mm
N-584-B	640 mm
N-584-C	790 mm
N-584-D	990 mm

* Compatível com N-587 / N-620

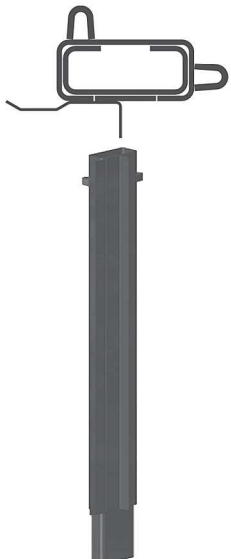
N-585

Fuego Canto Superior Direito

COD.	MEDIDAS
N-585-A	683 mm
N-585-B	803 mm
N-585-C	1003 mm

* Compatível com N-588 / N-621

N-586

Fuego Canto Superior Esquerdo

COD.	MEDIDAS
N-586-A	683 mm
N-586-B	803 mm
N-586-C	1003 mm

* Compatível com N-588 / N-621

N-587

Ferragem Tampa Lateral Inferior

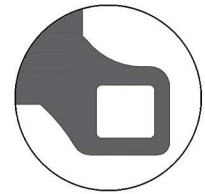
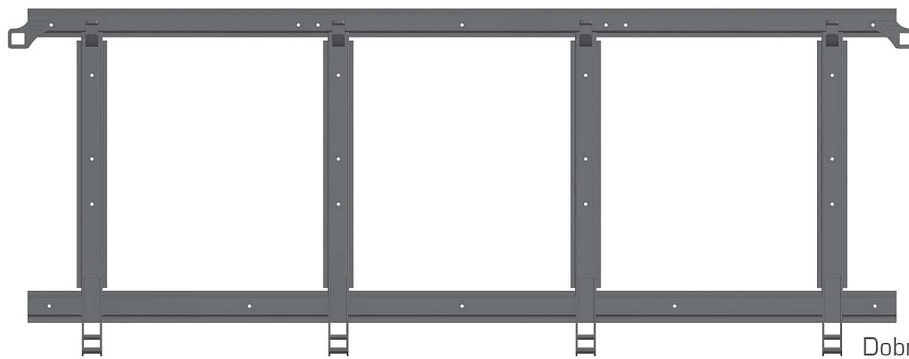

 Fueiro compatível:
 Altura da Presilha 57mm

 Dobradiça 200mm
 (N-535)

Ferragens Carga Seca							
COD.	MEDIDAS	COD.	MEDIDAS	COD.	MEDIDAS	COD.	MEDIDAS
N-587-A	500 x 2217mm	N-587-D	640 x 2217mm	N-587-G	790 x 2217mm	N-587-J	990 x 2217mm
N-587-B	500 x 2365mm	N-587-E	640 x 2365mm	N-587-H	790 x 2365mm	N-587-K	990 x 2365mm
N-587-C	500 x 2865mm	N-587-F	640 x 2865mm	N-587-I	790 x 2865mm	N-587-L	990 x 2865mm

N-588

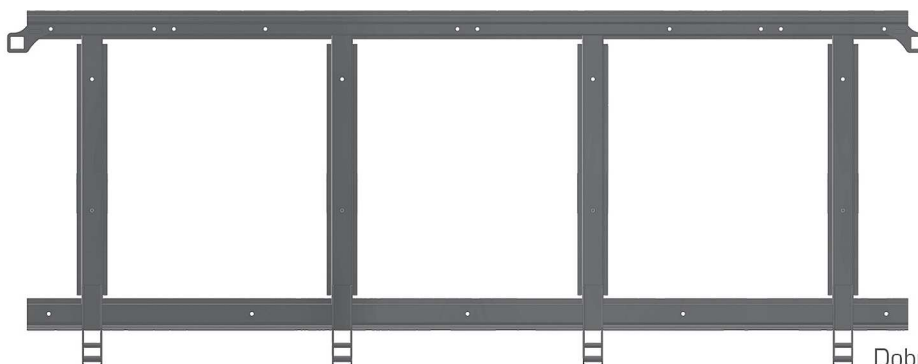
Ferragem Tampa Lateral Superior

 Fueiro compatível:
 Altura da Presilha 57mm

 Dobradiça 200mm
 (N-535)

COD.	MEDIDAS	COD.	MEDIDAS	COD.	MEDIDAS
N-588-A	653 x 2217mm	N-588-D	803 x 2217mm	N-588-G	1003 x 2217mm
N-588-B	653 x 2365mm	N-588-E	803 x 2365mm	N-588-H	1003 x 2365mm
N-588-C	653 x 2865mm	N-588-F	803 x 2865mm	N-588-I	1003 x 2865mm

Ferragens Laterais Fênix I (2012 e 2013): montadas c/dobradiça 200mm.

N-589

Ferragem Traseira Inferior
(com Tombador)

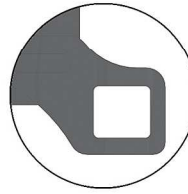

Fueiro compatível:
Altura da Presilha 57mm

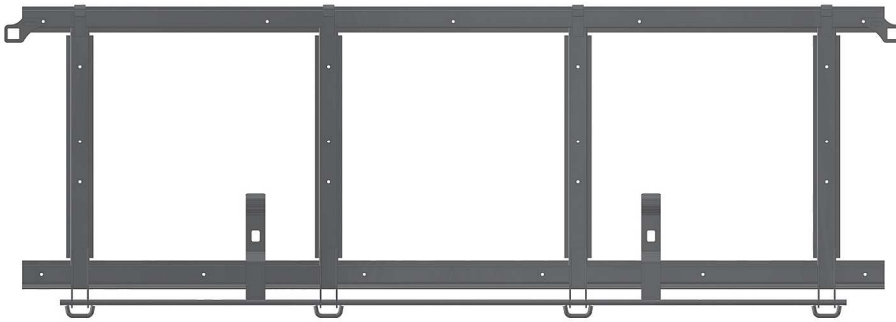

COD.	MEDIDAS
N-589-A	500 x 2445mm
N-589-B	640 x 2445mm
N-589-C	790 x 2445mm
N-589-D	990 x 2445mm

Dobradiça 167mm
(N-597-A)



N-599

Conjunto do Tombador Inferior



N-590

Ferragem Traseira Superior

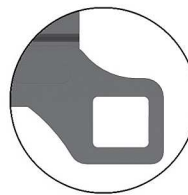

Fueiro compatível:
Altura da Presilha 57mm



COD.	MEDIDAS
N-590-A	653 x 2445mm
N-590-B	803 x 2445mm
N-590-C	1003 x 2445mm

Dobradiça 167mm
(N-597-B)



Ferragens Traseiras Fênix I (2012 e 2013): montadas c/dobradiça 167mm.

FERRAGENS - FÊNIX II - a partir de 2014
N-620

Ferragem Tampa Lateral Inferior

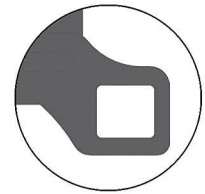
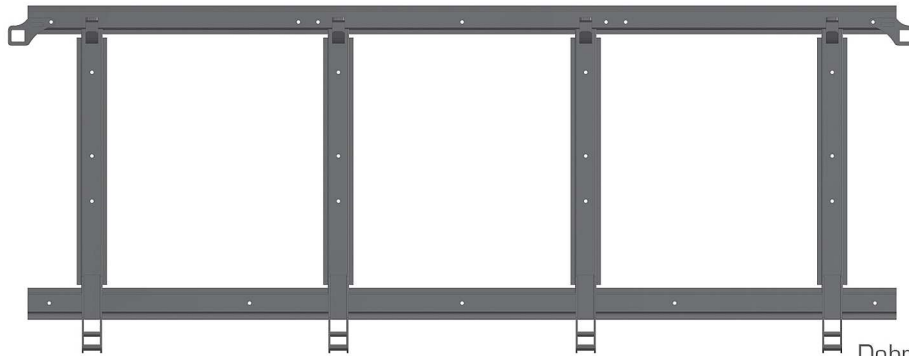

 Fueiro compatível:
 Altura da Presilha 57mm

 Dobradiça 174mm
 (N-534)

COD.	MEDIDAS	COD.	MEDIDAS	COD.	MEDIDAS
N-620-A	640 x 2217mm	N-620-D	790 x 2217mm	N-620-G	990 x 2217mm
N-620-B	640 x 2365mm	N-620-E	790 x 2365mm	N-620-H	990 x 2365mm
N-620-C	640 x 2865mm	N-620-F	790 x 2865mm	N-620-I	990 x 2865mm

N-621

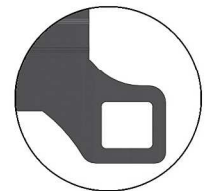
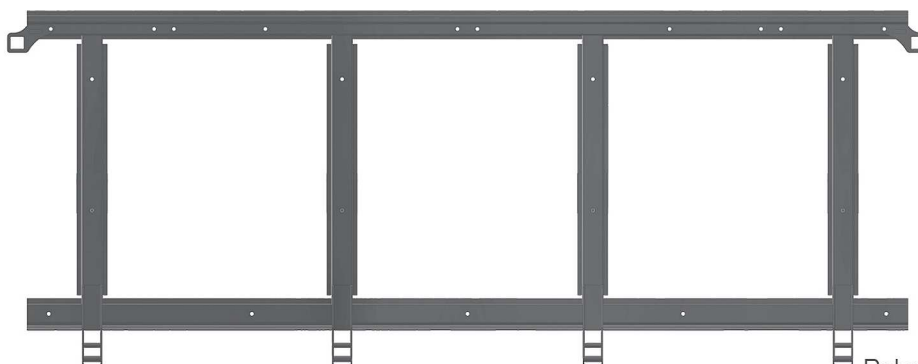
Ferragem Tampa Lateral Superior

 Fueiro compatível:
 Altura da Presilha 57mm

 Dobradiça 174mm
 (N-534)

COD.	MEDIDAS	COD.	MEDIDAS	COD.	MEDIDAS
N-621-A	653 x 2217mm	N-621-D	803 x 2217mm	N-621-G	1003 x 2217mm
N-621-B	653 x 2365mm	N-621-E	803 x 2365mm	N-621-H	1003 x 2365mm
N-621-C	653 x 2865mm	N-621-F	803 x 2865mm	N-621-I	1003 x 2865mm

Ferragens Laterais Fênix II (a partir de 2014): montadas c/dobradiça 174mm.

N-622

Ferragem Traseira Inferior
(com Tombador)

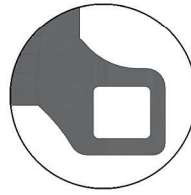

Fueiro compatível:
Altura da Presilha 57mm

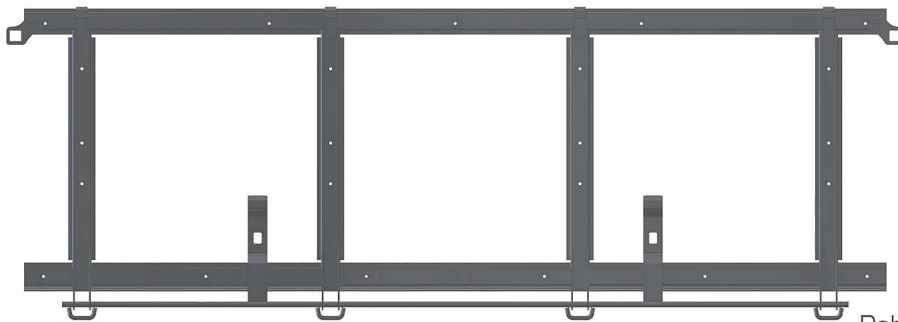

COD.	MEDIDAS
N-622-A	640 x 2445mm
N-622-B	790 x 2445mm
N-622-C	990 x 2445mm

Dobradiça 167mm
(N-597-B)



N-599

Conjunto do Tombador Inferior



N-623

Ferragem Traseira Superior

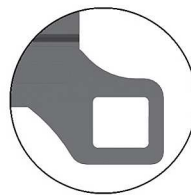

Fueiro compatível:
Altura da Presilha 57mm

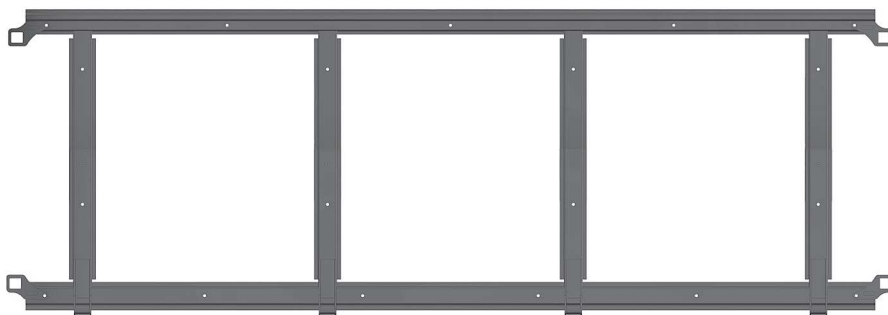

COD.	MEDIDAS
N-623-A	653 x 2445mm
N-623-B	803 x 2445mm
N-623-C	1003 x 2445mm

Dobradiça 167mm
(N-597-B)



Ferragens Traseiras Fênix II (a partir de 2014): montadas c/dobradiça 167mm.

FRONTAIS - TITANIUM / largura 2548mm

ESTES PRODUTOS CONTÉM SOMENTE A FERRAGEM DO QUADRO.

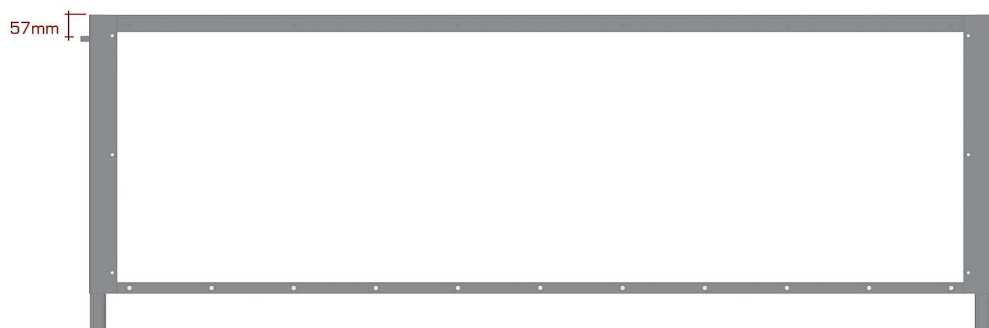

N-624
Batente Reto

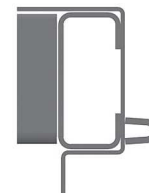

N-624

Frontal de Graneleira Inferior

COD.	MEDIDAS
N-624-A	640 mm
N-624-B	790 mm
N-624-C	890 mm
N-624-D	990 mm

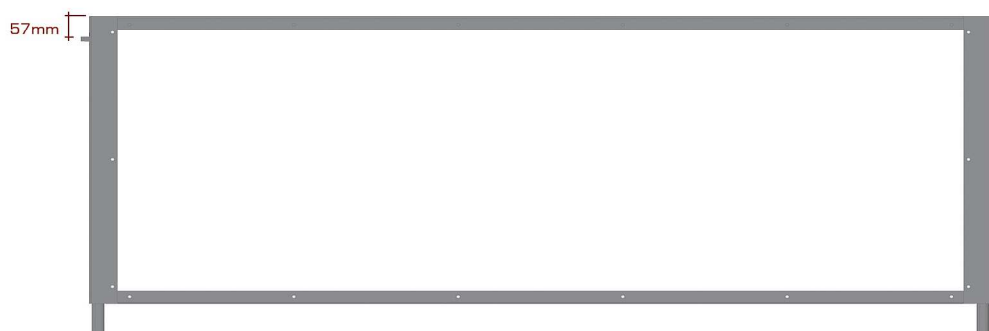

N-625
Batente Reto

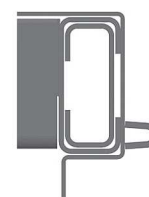

N-625

Frontal de Graneleira Superior

COD.	MEDIDAS
N-625-A	653 mm
N-625-B	803 mm
N-625-C	903 mm
N-625-D	1003 mm

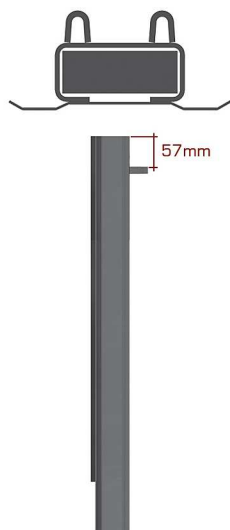
N-626

Fueiro Lateral Inferior

COD.	MEDIDAS
N-626-A	640 mm
N-626-B	790 mm
N-626-C	890 mm
N-626-D	990 mm

* Compatível com N-632

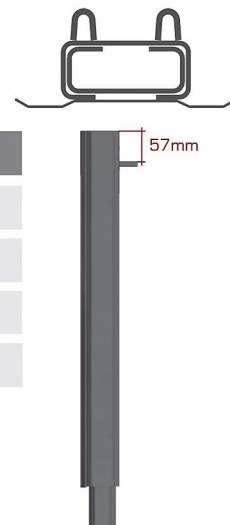
N-627

Fueiro Lateral Superior

COD.	MEDIDAS
N-627-A	653 mm
N-627-B	803 mm
N-627-C	903 mm
N-627-D	1003 mm

* Compatível com N-633

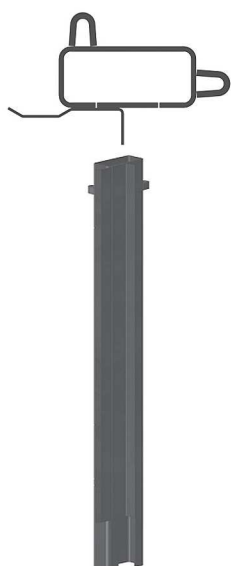
N-628

Fueiro Canto Inferior Direito

COD.	MEDIDAS
N-628-A	640 mm
N-628-B	790 mm
N-628-C	890 mm
N-628-D	990 mm

* Compatível com N-632

N-629

Fueiro Canto Inferior Esquerdo

COD.	MEDIDAS
N-629-A	640 mm
N-629-B	790 mm
N-629-C	890 mm
N-629-D	990 mm

* Compatível com N-632

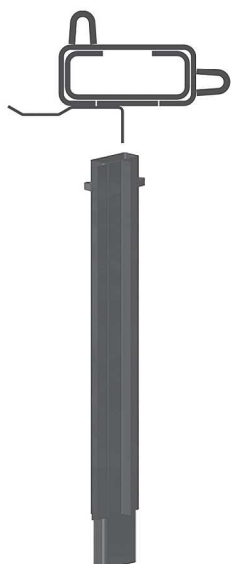
N-630

Fueiro Canto Superior Direito

COD.	MEDIDAS
N-630-A	653 mm
N-630-B	803 mm
N-630-C	903 mm
N-630-D	1003 mm

* Compatível com N-633

N-631

Fueiro Canto Superior Esquerdo

COD.	MEDIDAS
N-631-A	653 mm
N-631-B	803 mm
N-631-C	903 mm
N-631-D	1003 mm

* Compatível com N-633

N-632

Ferragem Tampa Lateral Inferior

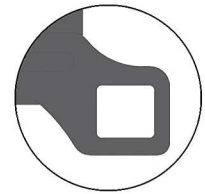
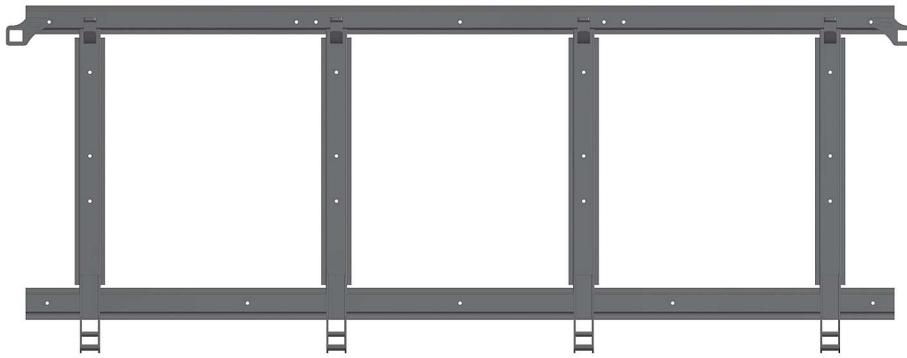
 Fueiro compatível:
 Altura da Presilha 57mm

COD.	MEDIDAS	COD.	MEDIDAS	COD.	MEDIDAS	COD.	MEDIDAS
N-632-A	640 x 2217mm	N-632-D	790 x 2217mm	N-632-G	890 x 2217mm	N-632-J	990 x 2217mm
N-632-B	640 x 2365mm	N-632-E	790 x 2365mm	N-632-H	890 x 2365mm	N-632-K	990 x 2365mm
N-632-C	640 x 2865mm	N-632-F	790 x 2865mm	N-632-I	890 x 2865mm	N-632-L	990 x 2865mm

N-633

Ferragem Tampa Lateral Superior

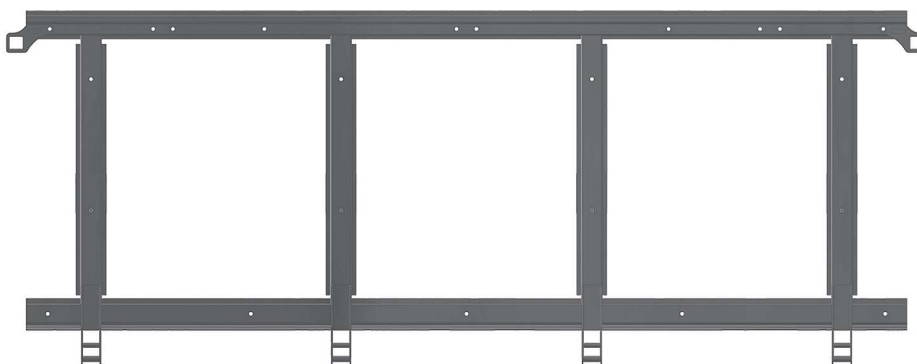
 Fueiro compatível:
 Altura da Presilha 57mm

COD.	MEDIDAS	COD.	MEDIDAS	COD.	MEDIDAS	COD.	MEDIDAS
N-633-A	653 x 2217mm	N-633-D	803 x 2217mm	N-633-G	903 x 2217mm	N-633-J	1003 x 2217mm
N-633-B	653 x 2365mm	N-633-E	803 x 2365mm	N-633-H	903 x 2365mm	N-633-K	1003 x 2365mm
N-633-C	653 x 2865mm	N-633-F	803 x 2865mm	N-633-I	903 x 2865mm	N-633-L	1003 x 2865mm

N-634

Ferragem Traseira Inferior
(com Tombador)

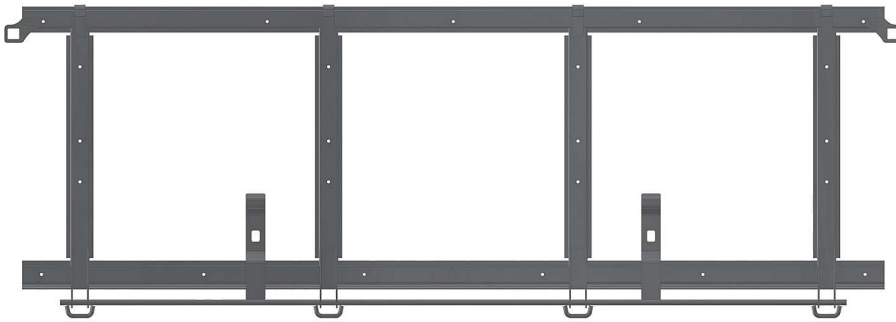
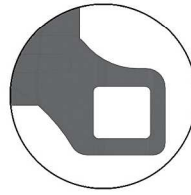

Fueiro compatível:
Altura da Presilha 57mm

COD.	MEDIDAS
N-634-A	640 x 2445mm
N-634-B	790 x 2445mm
N-634-C	890 x 2445mm
N-634-D	990 x 2445mm

N-599

Conjunto do Tombador Inferior



N-635

Ferragem Traseira Superior

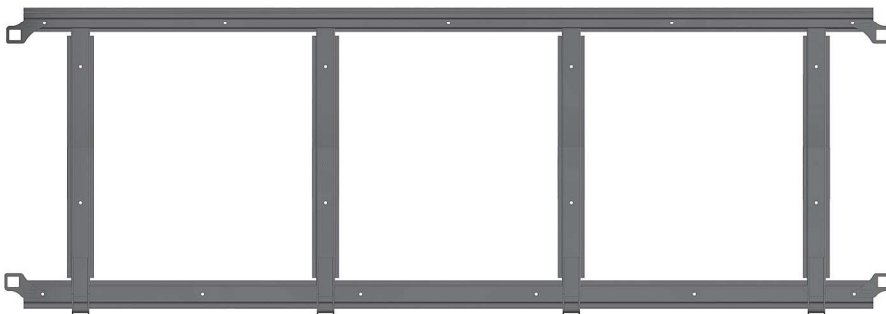
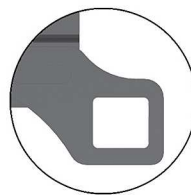

Fueiro compatível:
Altura da Presilha 57mm

COD.	MEDIDAS
N-635-A	653 x 2445mm
N-635-B	803 x 2445mm
N-635-C	903 x 2445mm
N-635-D	1003 x 2445mm



VIGUETAS - FÊNIX
N-593

Vigüeta Inferior da Tampa Superior e Inferior

COD.	MEDIDAS
N-593-A	2217mm
N-593-B	2365mm
N-593-C	2445mm
N-593-D	2865mm

N-594

Vigüeta Superior da Tampa Inferior

COD.	MEDIDAS
N-594-A	2217mm
N-594-B	2365mm
N-594-C	2445mm
N-594-D	2865mm

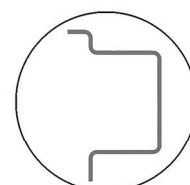
N-595

Vigüeta Superior da Tampa Superior

COD.	MEDIDAS
N-595-A	2217mm
N-595-B	2365mm
N-595-C	2445mm
N-595-D	2865mm



Vista da furação lateral



Vista da furação superior

FUEIROS DA TAMPA - FÊNIX
N-591

Fueiro da Tampa Inferior

COD.	MEDIDAS	ALT. TAMPA
N-591-A	387 mm	500 mm
N-591-B	525 mm	640 mm
N-591-C	675 mm	790 mm
N-591-D	875 mm	990 mm

N-592

Fueiro da Tampa Superior

COD.	MEDIDAS	ALT. TAMPA
N-592-A	537 mm	653 mm
N-592-B	687 mm	803 mm
N-592-C	887 mm	1003 mm

N-542

Lateral da Carreta 3000mm

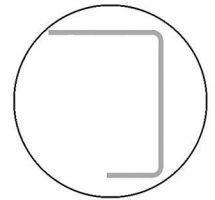

N-543

Perfil Dianteiro 2446mm

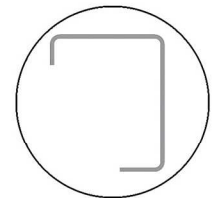

N-543-A

Perfil Dianteiro - Freio ABS (Fênix)

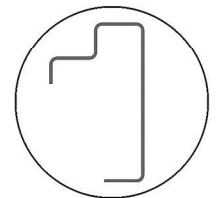

N-596

Engate Fêmea



N-523

Dobradiça da Tapa
Áquila (200mm)

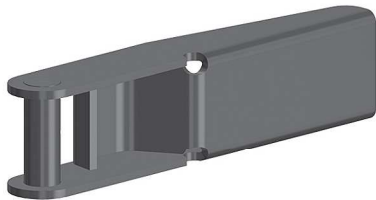

N-534

Dobradiça da Tapa Fênix (174mm)

N-535

Dobradiça da Tapa Fênix (200mm)

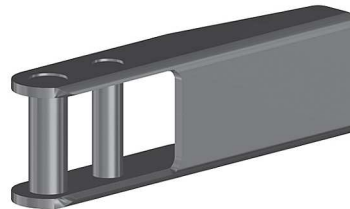

N-597-A

Dobradiça do Tombador
Inferior (167mm)



N-597-B

Dobradiça do Tombador
Superior (167mm)



N-519

Caixa do Fueiro

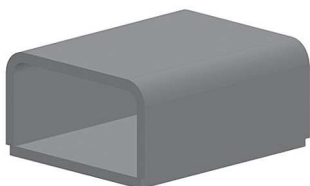

N-520

Encaixe do Fueiro Superior

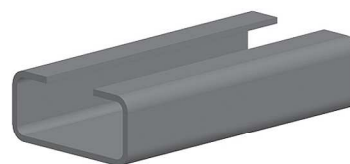

N-598

Puxador do Tombador



N-600

Trava do Gancho do Tombador



N-522

Engate Rápido Antigo

N-528

Engate Rápido Novo



N-601

Suporte Central da Saia (815mm)

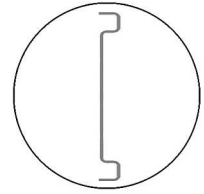

N-604

Suporte Central (815mm)

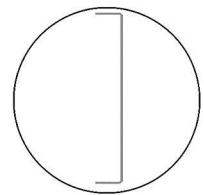
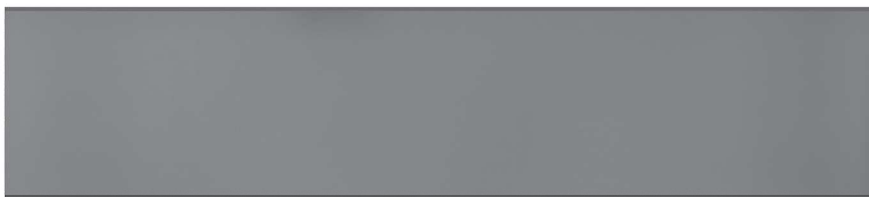

N-507

Cinta do Parabarro (660mm)





S-701
Batente c/1 Dobra

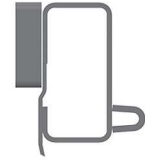

S-701
Frontal de Graneleira Inferior

COD.	MEDIDAS
S-701-D	700 mm
S-701-E	800 mm
S-701-F	1000 mm



S-702
Batente c/1 Dobra



S-702
Frontal de Graneleira Superior

COD.	MEDIDAS
S-702-D	700 mm
S-702-E	800 mm
S-702-F	1000 mm

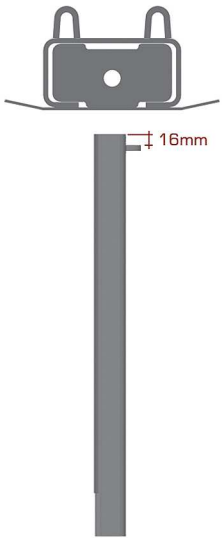

S-710
Fueiro Lateral Inferior

COD.	MEDIDAS
S-710-D	700 mm
S-710-E	800 mm
S-710-F	1000 mm

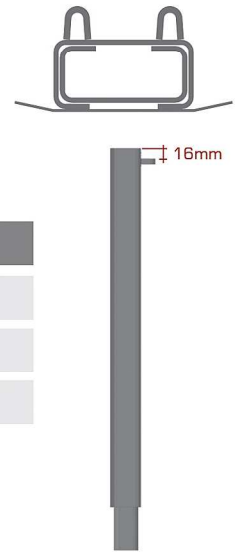

S-711
Fueiro Lateral Superior

COD.	MEDIDAS
S-711-D	700 mm
S-711-E	800 mm
S-711-F	1000 mm

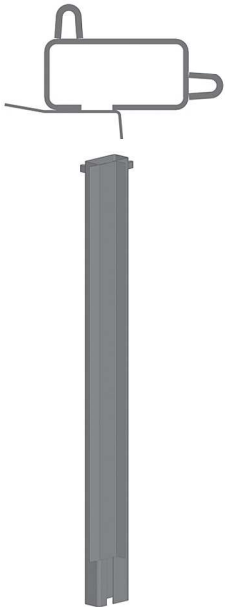

S-713
Fueiro Canto Inferior Direito

COD.	MEDIDAS
S-713-D	700 mm
S-713-E	800 mm
S-713-F	1000 mm

S-714
Fueiro Canto Inferior Esquerdo

COD.	MEDIDAS
S-714-D	700 mm
S-714-E	800 mm
S-714-F	1000 mm

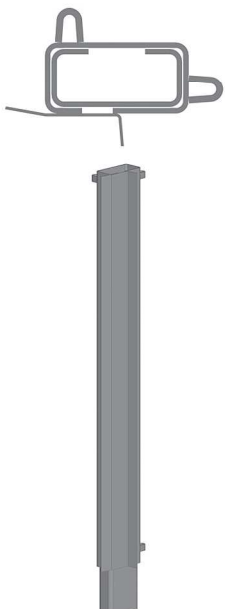

S-715
Fueiro Canto Superior Direito

COD.	MEDIDAS
S-715-D	700 mm
S-715-E	800 mm
S-715-F	1000 mm

S-716
Fueiro Canto Superior Esquerdo

COD.	MEDIDAS
S-716-D	700 mm
S-716-E	800 mm
S-716-F	1000 mm

S-731

Lateral da Carreta (3000mm)

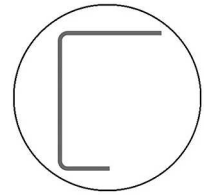

S-732

Perfil Dianteiro (2426mm)

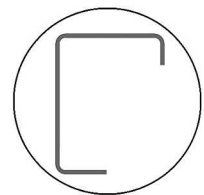

S-721

Presilha do Fueiro
altura 20mm

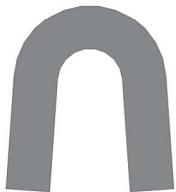

S-741

Fueiro da Tapa
Obs.: indicar comprimento.



S-719

Caixa do Fueiro

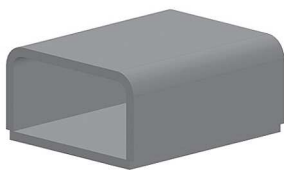

S-720

Encaixe do Fueiro

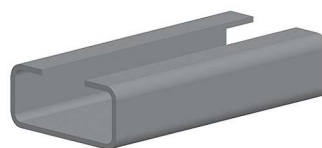

R-289

Conjunto do Tombador (Compatível c/Randon)



COD.	DESCRIÇÃO
R-289	Conjunto do Tombador
R-289-A	Conjunto do Tombador c/4 Alavancas
R-289-B	Conjunto do Tombador c/Dobradiça Reforçada (espess. 1/4")
R-289-C	Conjunto do Tombador c/4 Alavancas c/Dobrad.Reforç. (espess. 1/4")

R-290

Conjunto Tombador (Compatível c/Randon 70 anos)



COD.	DESCRIÇÃO
R-290-A	Alavanca
R-290-B	Conjunto Tombador Mod. Randon 70 anos
R-290-C	Conjunto Tombador Mod. Randon 70 anos c/Dobradiça Reforçada

G-536

Conjunto do Tombador (Compatível c/Guerra)



COD.	DESCRIÇÃO
G-536	Conjunto do Tombador
G-536-A	Conjunto do Tombador c/4 Alavancas
G-536-B	Conjunto do Tombador c/Dobradiça Reforçada
G-536-C	Conjunto do Tombador c/4 Alavancas e Dobradiça Reforçada

L-946

Conjunto do Tombador (Compatível c/Librelato)

N-599

Conjunto do Tombador (Compatível c/Noma)

F-701

Conjunto do Tombador (Compatível c/Facchini)

* observar medida do varão



COD.	DESCRIÇÃO
F-701	Conjunto do Tombador (varão 2170mm p/Ferragens c/Engate F-604)
F-701-A	Conjunto do Tombador (varão 2260mm p/Ferragens c/Engate F-702)

Modelo até 2020 (largura chassi 955mm)

R-236-A

Travessa Passante 2530mm

R-236-B

Travessa Passante 2595mm

R-236-C

Travessa Passante 2420mm

Modelo 2021 (largura chassi 1055mm)

R-236-D

Travessa Passante 2530mm

R-236-E

Travessa Passante 2595mm

R-236-F

Travessa Passante 2430mm

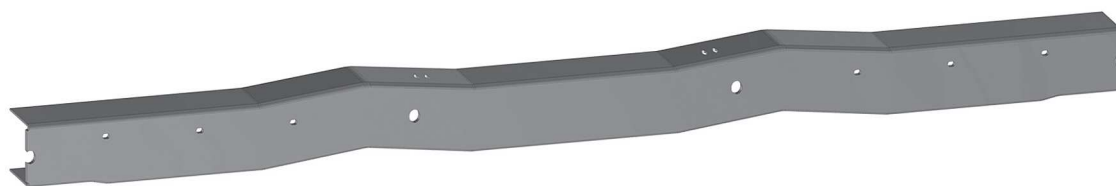

R-217

Travessa Central p/Falsa Passante 950mm

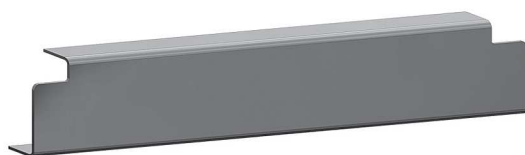

R-162

Mão Francesa LD

R-163

Mão Francesa LE



R-216-A

Falsa Passante LD

R-216-B

Falsa Passante LE

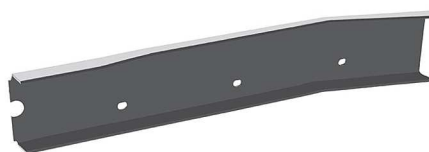

N-506

Travessa Passante 2530mm

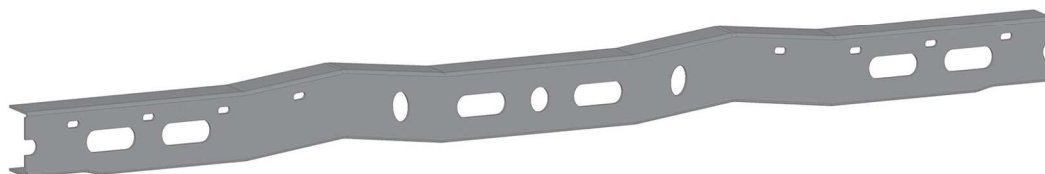

L-993-A

Travessa Passante 2535mm (Assoalho de Aço)

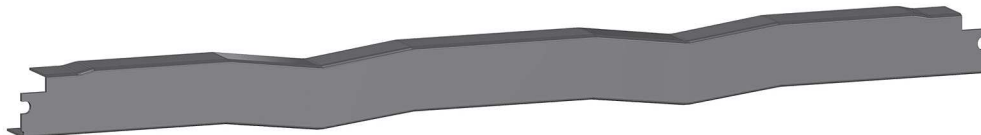

L-993-B

Travessa Passante 2535mm (Assoalho de Madeira)

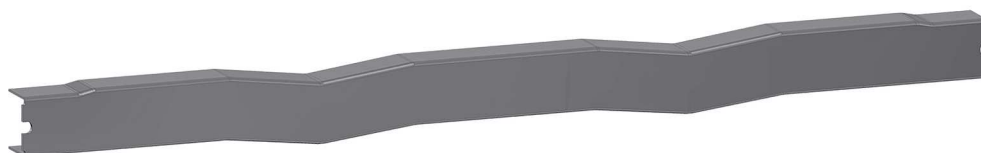

L-917

Travessa Central do Chassi
p/Falsa Passante (945mm)



L-959-A

Reforço da Passante LD

L-959-B

Reforço da Passante LE



G-610

Travessa Passante 2530mm

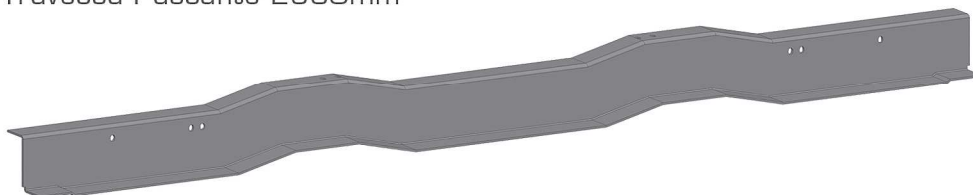

G-609

Travessa Central p/Falsa Passante



G-608-A

Falsa Passante LD

G-608-B

Falsa Passante LE



R-182-A

Boca de Graneleira
(Universal)



G-460

Boca de Graneleira
(Guerra)

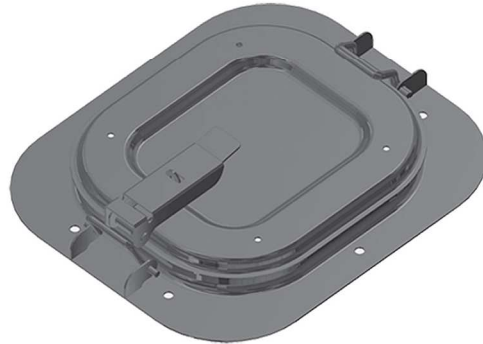

D-1004

Boca de Graneleira - Nylon
(Universal)



G-611

Boca de Graneleira - Nylon
(Guerra)

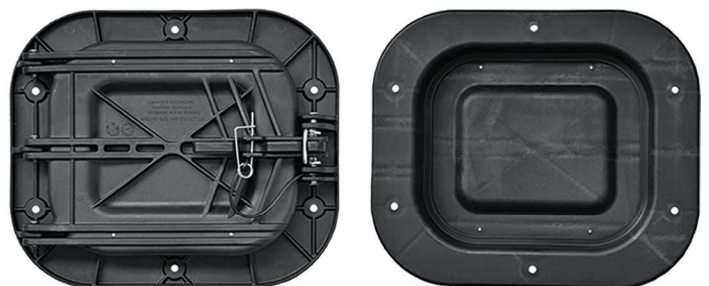

R-150-B

Arco (na Vigueta) 2520mm

R-150-C

Arco (na Vigueta) 2520mm (parede grossa)

R-150-F

Arco (na Basculante) 2450mm

R-150-E

Arco (na Basculante) 2450mm (parede grossa)

N-603

Arco (na Vigueta) 2580mm (Mod. Noma: Fênix/Titanium)



Detalhe Estampa
Reforço na Dobra

R-150-A

Arco (no Suporte) 2380mm

R-150-D

Arco (no Suporte) 2380mm (parede grossa)



G-461

Arco de Contenção 2450mm



F-704

Arco (na Vigueta) 2500mm (Mod. Facchini)



Detalhe F-704

R-149-A

Suporte de Arco (chapa 3mm)

R-149-B

Suporte de Arco (chapa 2mm)



D-820

Catraca p/Cinta (Zincada Amarela)
até 50mm

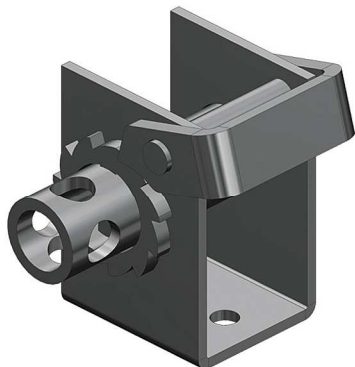

D-820-01

Fixador (Zincado Amarelo)



R-200

Catraca p/Cabo de Aço
(Mod. Randon)

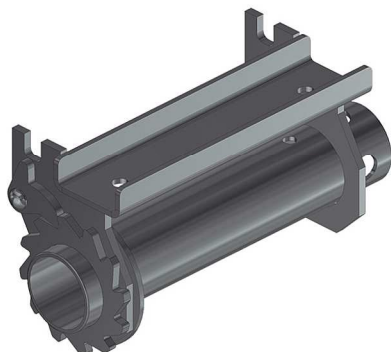

G-468

Catraca p/Cabo de Aço e Cinta
(Mod. Guerra) - até 100mm

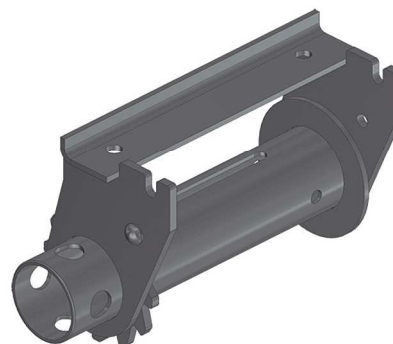

D-812

Catraca do Truck
p/Cabo de Aço



D-938

Catraca do Truck
p/Cinta 100mm

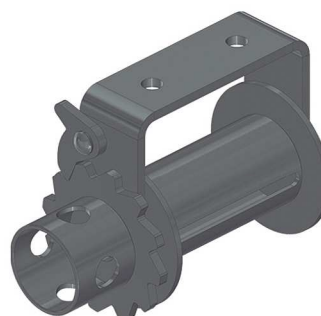

D-821-A

Catraca p/Cinta
c/Cantoneira
(Mod.Americano)

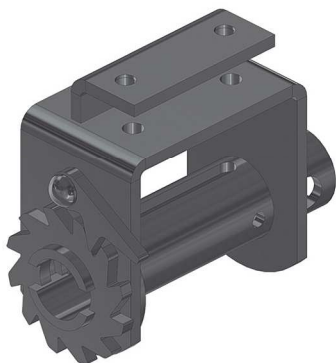

D-821-B

Catraca p/Cinta
s/Cantoneira c/Furo
(Mod. Americano)

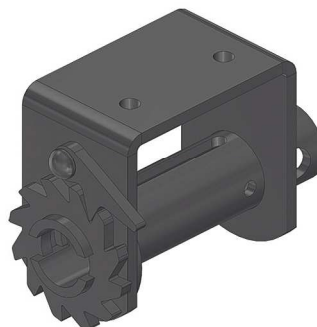

D-821-C

Catraca p/Cinta 50/60/70mm
s/Cantoneira c/Furo
(Mod.Americano)

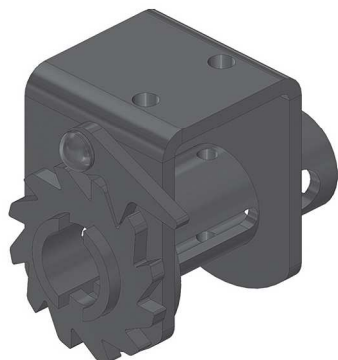

F-650-A

Catraca p/Cinta s/Reforço
(Mod. Facchini) - até 100mm

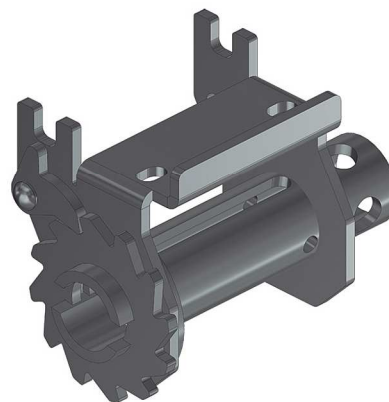

D-819-A

Catraca p/Cinta
s/Reforço

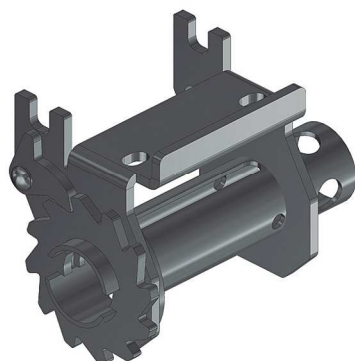

D-819-01

Reforço da Catraca
p/Cinta



PARA-CHOQUE 6,5 - 10 TON.

Para-choque Homologado para 6,5 - 10 Ton. PBT

- 01 - D-880-C Lâmina do Para-choque (2100mm)
- 02 - D-880-K Coluna Montada
- 02 - D-880-D Travessa Lateral (420mm)
- 01 - D-880-F Reforço Interno (195mm)
- 01 - D-880-H Travessa Central (715mm)
- 02 - D-880-G Mola Tensora Para-choque (320mm)

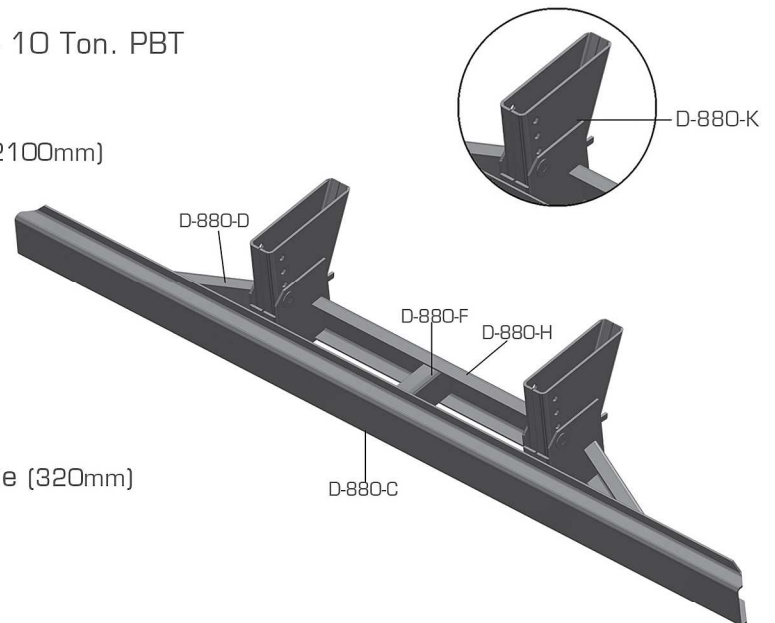

Relatório de aprovação nº 001/2016
Instituição emissora do relatório técnico: INSPEL LTDA

PARA-CHOQUE 23 TON.

Para-choque Homologado para 23 Ton. PBT

- 01 - D-881-C Lâmina do Para-choque (2400mm)
- 02 - D-881-K Coluna Montada
- 02 - D-881-D Travessa Lateral (600mm)
- 01 - D-881-F Reforço Interno (200mm)
- 01 - D-881-H Travessa Central (730mm)
- 02 - D-881-G Mola Tensora Para-choque (500mm)

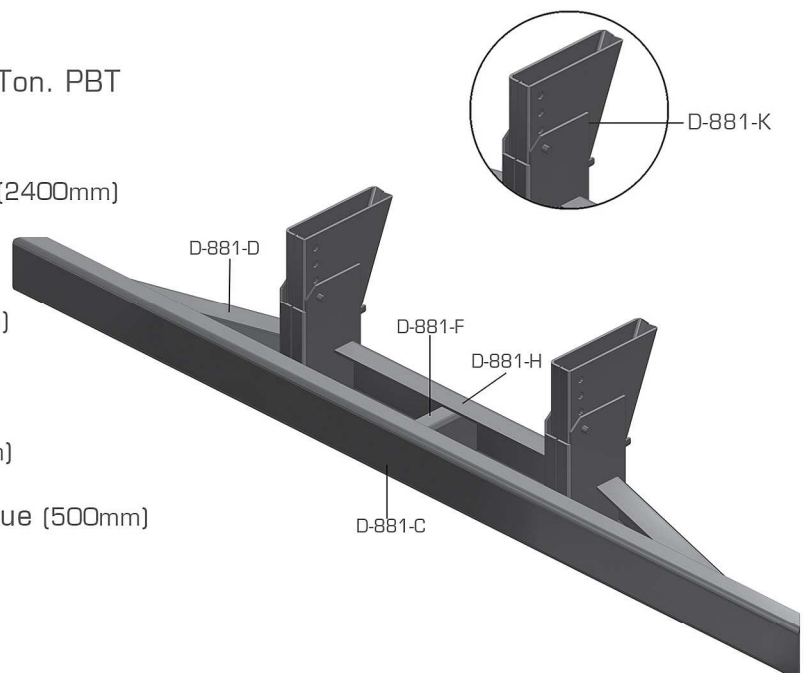

Relatório de aprovação nº 002/2016
Instituição emissora do relatório técnico: INSPEL LTDA

PARA-CHOQUE AJUSTÁVEL LONGO

Para-choque Ajustável Longo

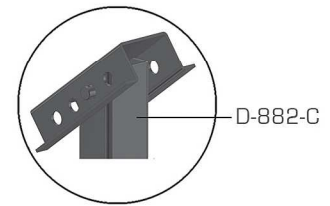

- 01 - **R-206-C** Lâmina do Para-choque 4 Dobras (2400mm)
- 02 - **D-882-C** Coluna Montada
- 02 - **D-881-G** Mola Tensora do Para-choque (500mm)

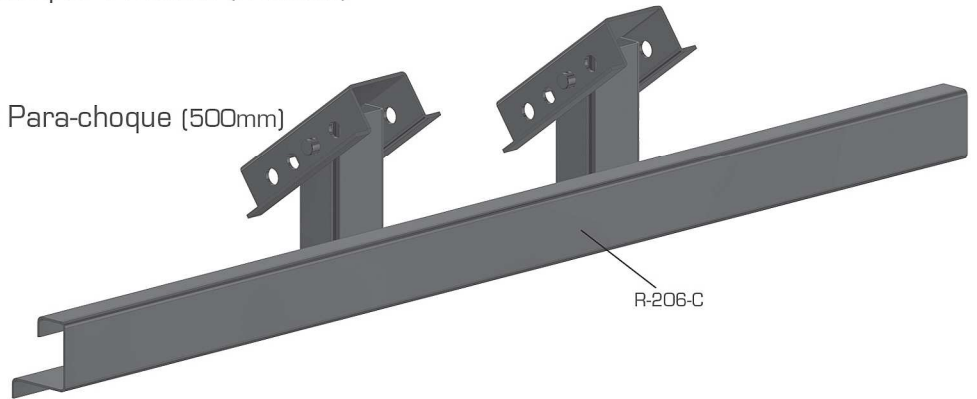

Relatório de aprovação nº 001/2019

PARA-CHOQUE AJUSTÁVEL CURTO

Para-choque Ajustável Curto

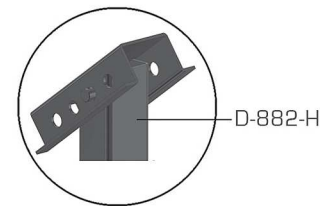

- 01 - **D-882-G** Lâmina do Para-choque 4 Dobras (2000mm)
- 02 - **D-882-H** Coluna Montada
- 02 - **D-881-G** Mola Tensora Para-choque (500mm)

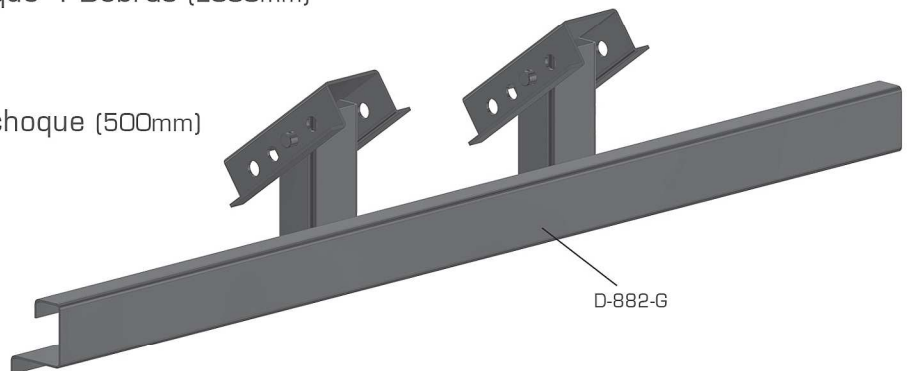

Relatório de aprovação nº 002/2019

COLUNA MÓVEL - TRUCK

- D-898-A**
Coluna Móvel Para-choque Truck (450mm)
- D-898-B**
Coluna Móvel Para-choque Truck (550mm)
- D-898-C**
Coluna Móvel Para-choque Truck (650mm)



PARA-CHOQUE ANTIGO (COMPATIVEL C/: RANDON)

Para-choque Antigo

01 - **R-204-A** Lâmina do Para-choque (2300mm)

02 - **R-204-B** Coluna Para-choque (840mm)

02 - **R-204-C** Reforço Interno Para-choque

02 - **R-204-D** Reforço Para-choque

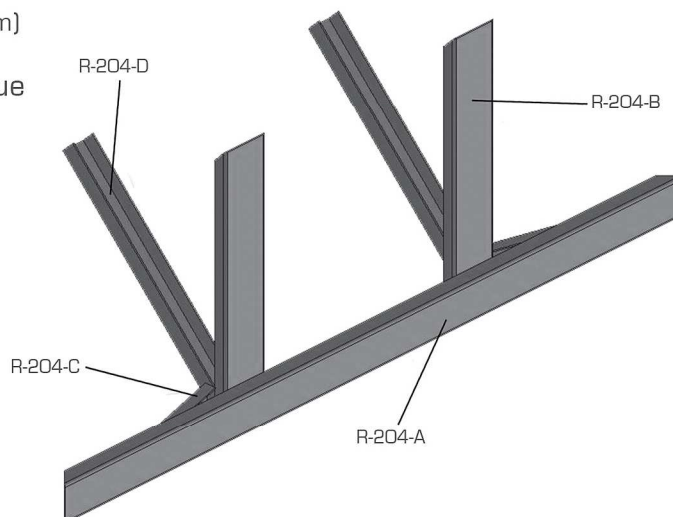

PARA-CHOQUE 4 DOBRAS (COMPATIVEL C/: RANDON)

Para-choque 4 Dobras

01 - **R-206-C** Lâmina do Para-choque 4 Dobras (2400mm)

01 - **R-206-A** Coluna Para-choque c/Rasgo (925mm)

01 - **R-206-B** Coluna Para-choque s/Rasgo (925mm)

02 - **R-206-D** Reforço Para-choque

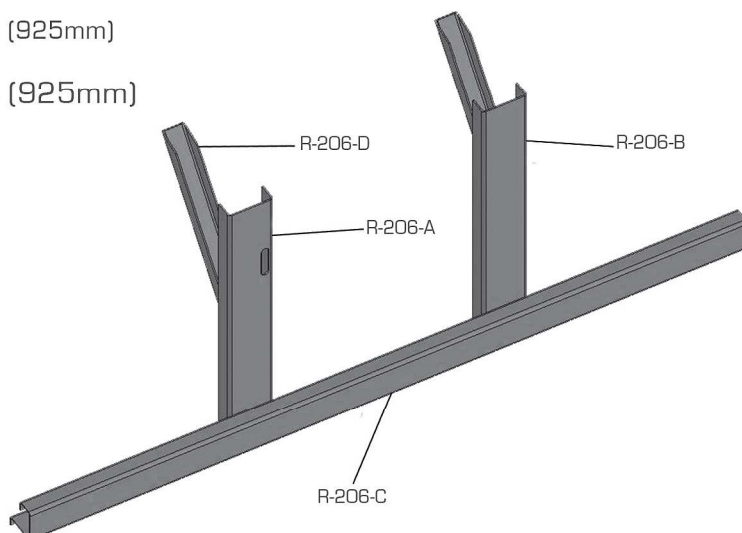

PARA-CHOQUE DIANTEIRO DO BITREM (COMPATIVEL C/: RANDON)

Para-choque Antigo do Bitrem

- 01 - **R-208-A** Lâmina do Para-choque (1800mm)
- 02 - **R-208-B** Coluna Para-choque (550mm)
- 01 - **R-208-C** Travessa Superior (2460mm)

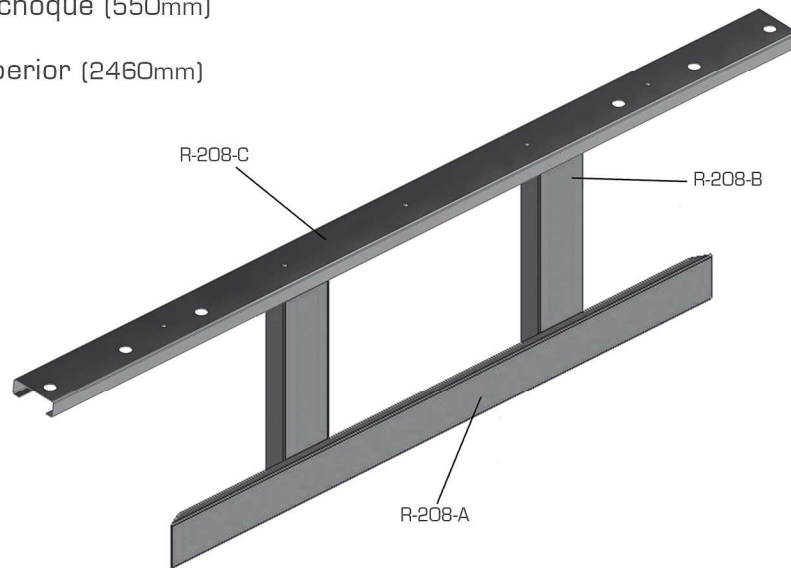

PARA-CHOQUE CARRETA (COMPATIVEL C/: RANDON)

Para-choque Carreta Randon

- 01 - **R-207-A** Lâmina do Para-choque (2400mm)
- 01 - **R-207-G** Coluna Montada c/Rasgo
- 01 - **R-207-H** Coluna Montada s/Rasgo
- 01 - **R-207-C** Kit Embuchamento Ø38mm
- 01 - **R-207-F** Gancho do Para-choque
- 02 - **D-880-G** Mola Tensora Para-choque (320mm)

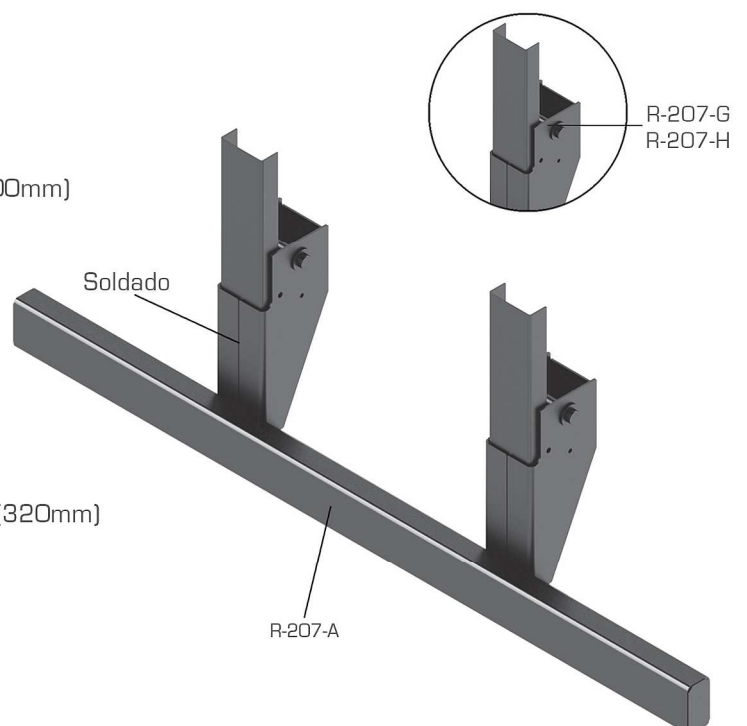

PARA-CHOQUE DIANTEIRO DO BITREM (COMPATÍVEL C/ GUERRA)

Para-choque Dianteiro do Bitrem

- 01 - **G-570-B** Lâmina do Para-choque (2300mm)
- 01 - **G-570-A** Travessa Superior (2350mm)
- 02 - **G-570-C** Coluna Fixa (600mm)
- 02 - **G-570-D** Reforço Vertical (500mm)
- 01 - **G-570-E** Reforço Interno LD (500mm)
- 01 - **G-570-F** Reforço Interno LE (500mm)

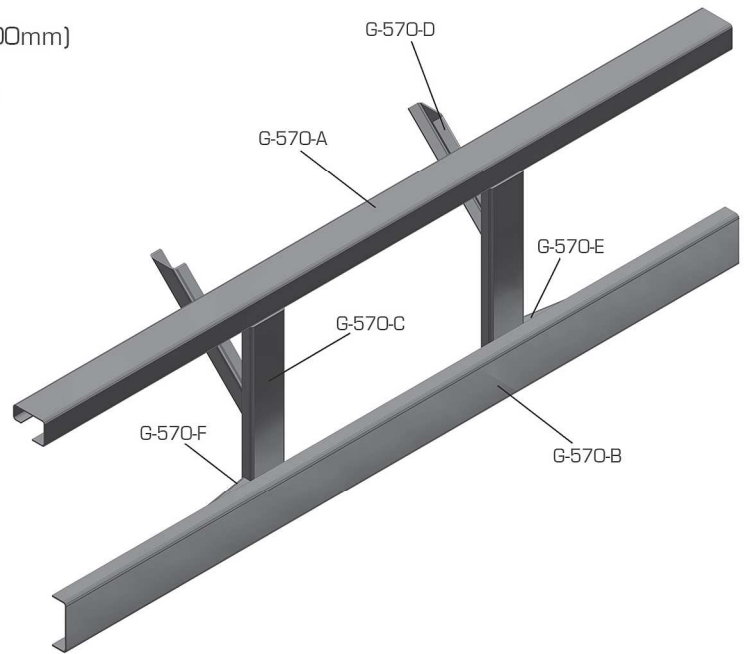

PARA-CHOQUE ANTIGO (COMPATÍVEL C/ GUERRA)

Para-choque Antigo

- 01 - **G-487-A** Lâmina do Para-choque (2400mm)
- 02 - **G-487-B** Coluna Móvel (920mm)

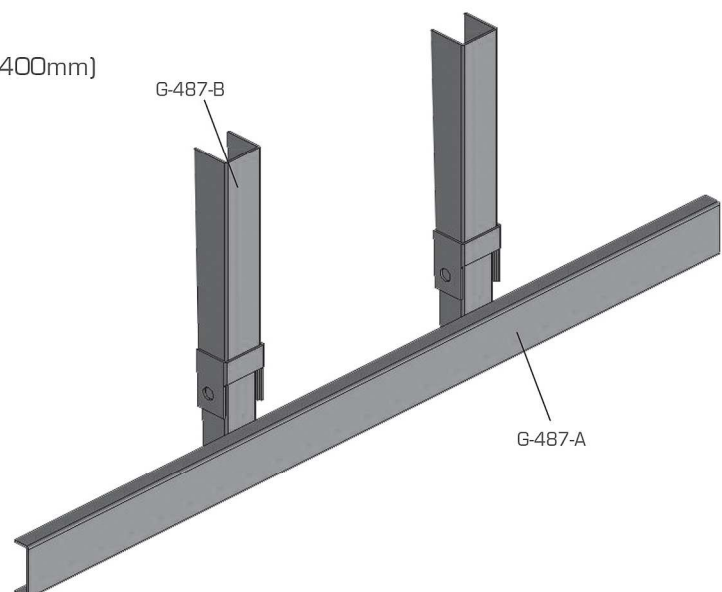

Para-choque Mod. Tecno 10

- 01 - **G-571-G** Lâmina Para-choque (2400mm)
- 02 - **G-571-H** Coluna Montada Para-choque
- 01 - **G-571-D** Reforço da Lâmina LD
- 01 - **G-571-E** Reforço da Lâmina LE
- 01 - **G-571-F** Reforço Horizontal (785mm)
- 02 - **G-571-A** Suporte "U" para Bascular o Para-choque
- 02 - **D-881-G** Mola Tensora para-choque (500mm)

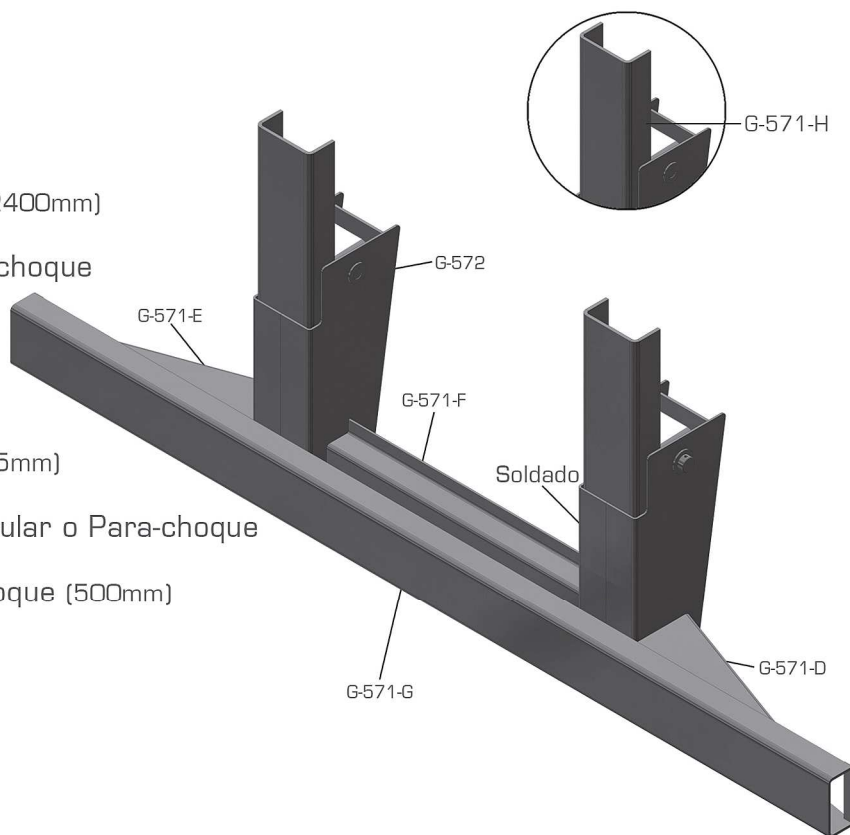

G-572

Kit Embuchamento Para-choque
Pino Ø 35mm

G-573

Kit Embuchamento Para-choque
Pino Ø 42mm



PL-018

Faixa Refletiva
do Para-Choque



R-390

Placa Sinalização Veículo Longo
(Mod. Randon)

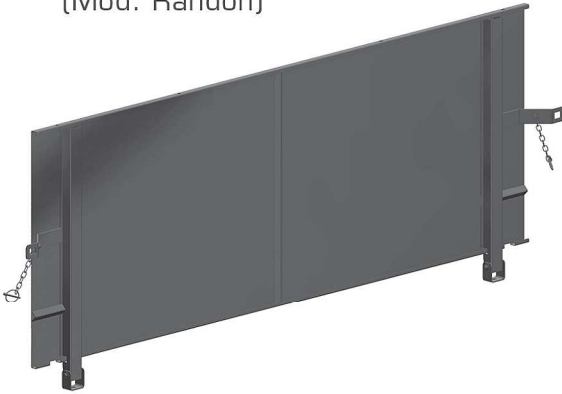

F-709

Placa Sinalização Veículo Longo
(Mod. Facchini)



L-967

Placa Sinalização Veículo Longo
(Mod. Librelato)

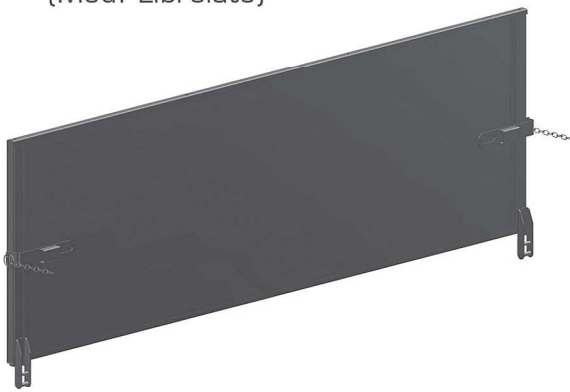

L-967-A

Placa Sinalização Veículo Longo
(Mod. Librelato Eco+)



N-619-A

Placa Sinalização Veículo Longo
(Mod. Noma)

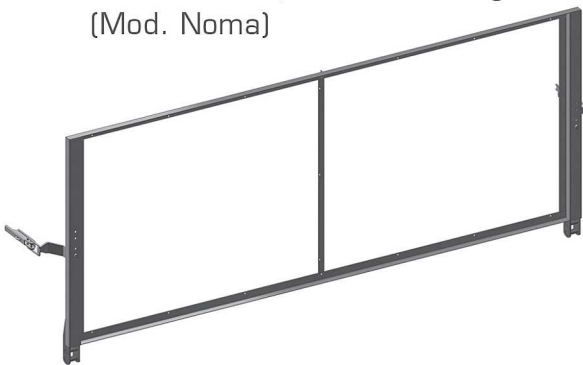

N-619-B

Placa Sinalização Veículo Longo
com Fechamento (Mod. Noma)



PL-017

Faixa Refletiva de Advertência
Veículo Longo



N-619-C

Suporte de Fixação
Placa Sinalização Veículo Longo
(Mod. Noma)



D-919

Coluna Móvel
Protetor de Ciclista LD

D-920

Coluna Móvel
Protetor de Ciclista LE



D-918

Coluna Fixa
Protetor de Ciclista



D-923

Protetor de Ciclista
p/Truck (870mm)

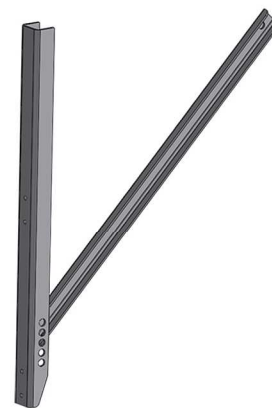

D-912

Perfil de Alumínio Prot.Ciclista (30x100x3000mm)

D-913

Perfil de Alumínio Prot.Ciclista (30x100x4000mm)



*Meramente Ilustrativa

D-915

Tampa Plástica (40x100mm)

D-915-A

Tampa Plástica (30x100mm)



D-916

Ponteira Plástica (40x100x510mm)

D-916-A

Ponteira Plástica (30x100x510mm)



COMPATÍVEL COM: LINHA FACCHINI

F-700

Conjunto Protetor de
Ciclista (Facchini)



N-613-A

Suporte Protetor de Ciclista LD
(Noma Titanium)

N-613-B

Suporte Protetor de Ciclista LE
(Noma Titanium)

N-613-C

Perfil Passante
Suporte Protetor de Ciclista
(Noma Titanium)

N-613-D

Perfil "U" Fixação Vertical
Suporte Protetor de Ciclista
(Noma Titanium)

N-613

Conjunto Suporte Protetor de Ciclista
(Noma Titanium)

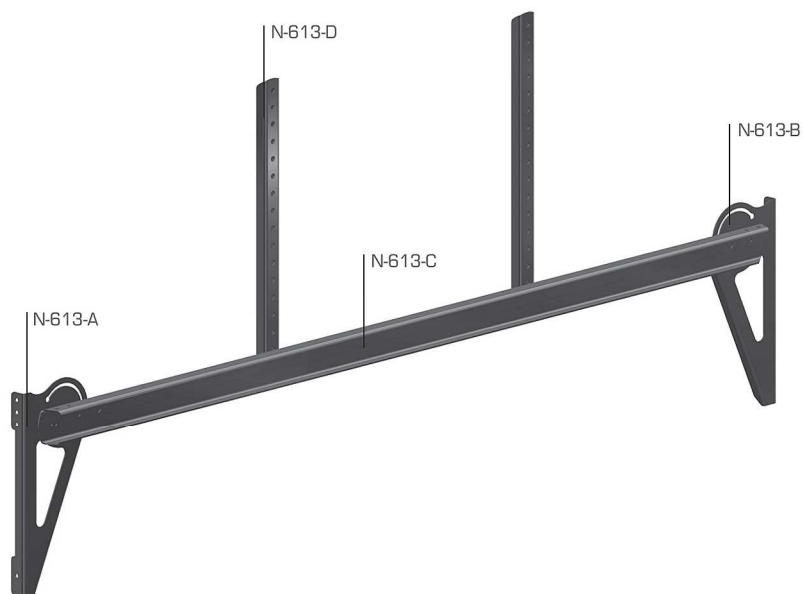

L-966

Suporte Protetor de
Ciclista (Librelato)



R-141-B

Tira Fino de Alumínio 2300 mm

R-141-D

Tira Fino de Alumínio 2960mm

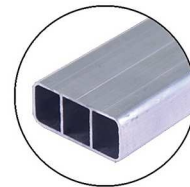

D-971

Tampa do Tira Fino
Tritubular (Fixação Interna)



G-491-B

Tira Fino de Alumínio 2300 mm

G-491-D

Tira Fino de Alumínio 2960mm

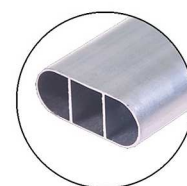

D-839-01

Tampa do Tira Fino
(Guerra)



COMPATÍVEL COM: LINHA RANDON

R-300

Mesa Pino Rei da Carreta

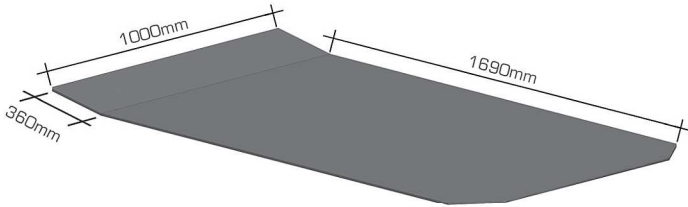

R-301

Mesa Pino Rei do Bitrem Dianteiro

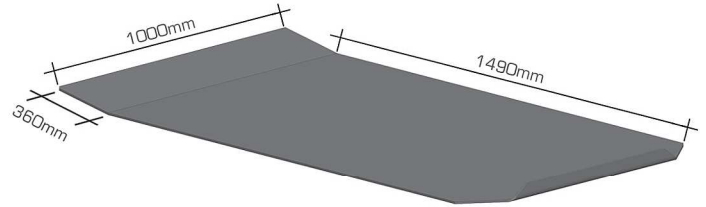

R-302

Mesa Pino Rei do Bitrem Traseiro

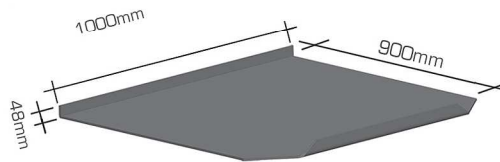

COMPATÍVEL COM: LINHA GUERRA

G-580

Mesa Pino Rei da Carreta

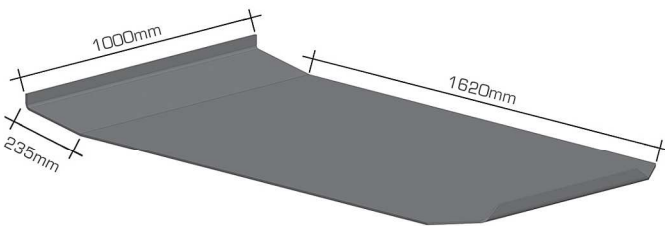

G-581

Mesa Pino Rei do Bitrem Dianteiro

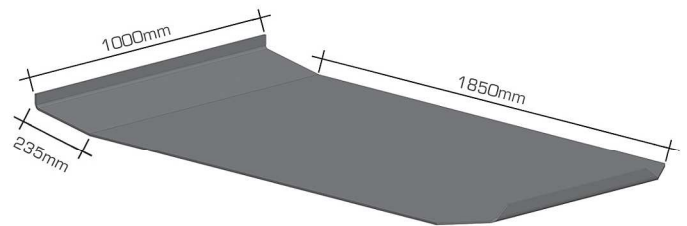

G-582

Mesa Pino Rei do Bitrem Traseiro

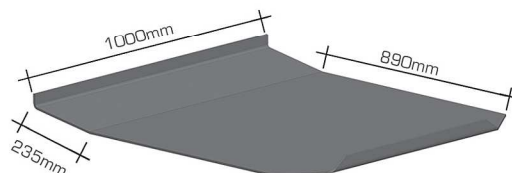

D-983-A

Separador de Rodas
10 Furos - Aro 20
(chapa 3,75mm)



D-983-B

Separador de Rodas
12 Furos - Aro 20
(chapa 3,75mm)



D-983-C

Separador de Rodas
12 Furos - Aro 22
(chapa 3,75mm)



PINOS FORQUILHA

RV-231

Pino Forquilha
(1/2")



RV-232

Pino Forquilha
(5/8")



R-218

Arruela Trava Randon
(espessura 3mm)

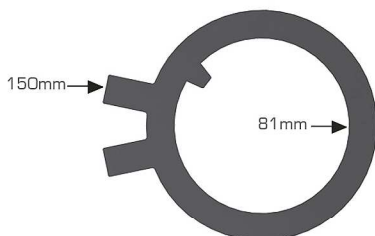

F-690

Arruela Dentada Moderna
(espessura 3mm)

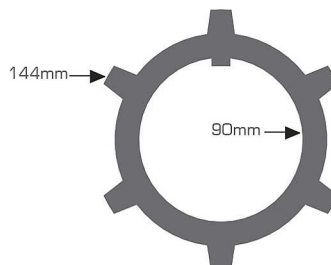

R-213

Arruela Encosto Randon
(espessura 3mm)

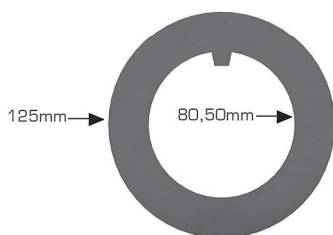

D-847

Arruela Encosto Lisa Diversos
(espessura 3,75mm)

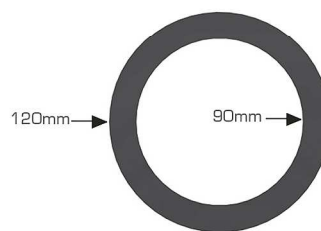

B-852

Arruela do "S"
Bendix

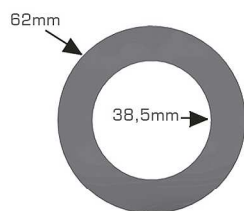

R-221

Arruela do "S"
Randon

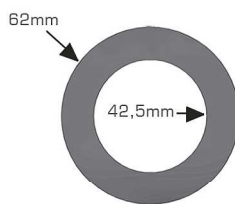

M-851

Arruela do "S"
Master

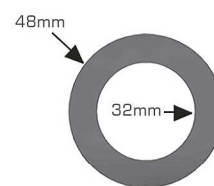

D-846-A

Arruela Lisa
(5/8")

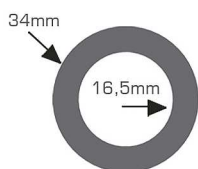

D-846-B

Arruela Lisa
(1/2")

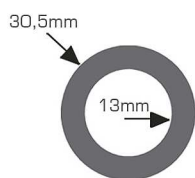

D-846-E

Arruela Lisa
(3/8")

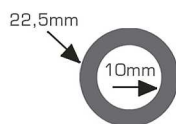

D-846-C

Arruela Lisa
(5/16")

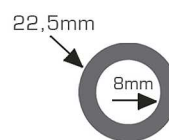

D-846-D

Arruela Lisa
(1/4")



LINHA METÁLICA

Padrão de Medidas: Altura x Largura x Profundidade



D-860

600x600x600mm (mod.Randon)

D-862

600x600x530mm (mod.Guerra)

D-863

600x900x530mm (mod.Guerra)

D-858

300x500x500mm (mod.Furgão)

D-1003

500x500x500mm (mod.Diversos)

D-1017

500x600x600mm (mod.Diversos)

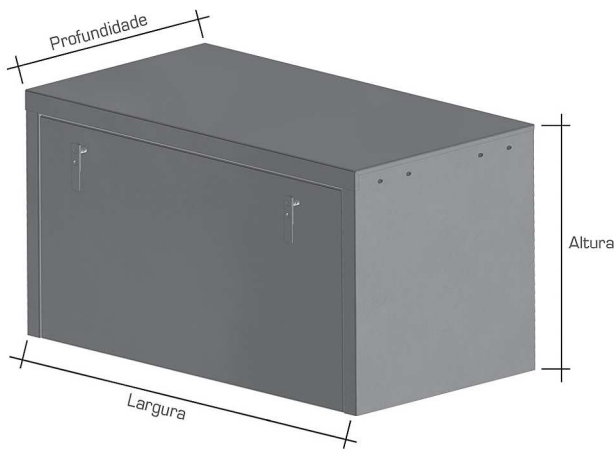

D-864

600x1000x600mm

D-859

600x1100x600mm

D-861

600x1140x600mm

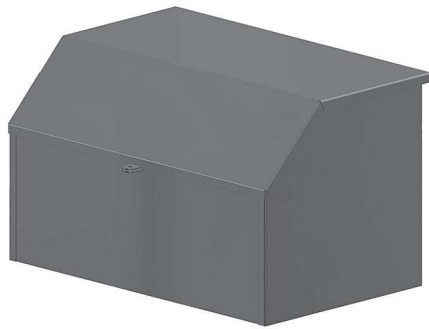

D-869

296x492x302mm (Cavalo Mecânico)

LINHA PLÁSTICA

RP-004

375x480x440mm (s/suportes)



RP-003

500x500x500mm (s/suportes)



D-811-A

Suporte Dobrado (Alt.93mm)

D-811-B

Suporte Dobrado (Alt.145mm)

D-811-C

Suporte Dobrado (Alt.50mm)



D-879-A

Suporte Fixação Caixa LD

D-879-B

Suporte Fixação Caixa LE

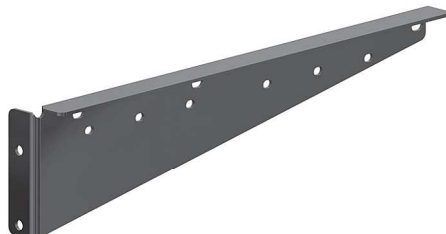

D-810

Suporte Reto

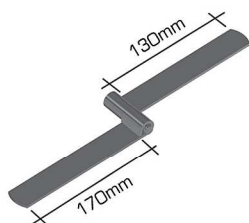

D-803-A

Dobradiça Caixa de Rancho LD
(sem furo)

D-803-B

Dobradiça Caixa de Rancho LE
(sem furo)



D-802

Cadeado Caixa de Rancho

D-802-A.1

Suporte Grande do Cadeado

COMPATÍVEL COM: LINHA RANDON

R-389-A

Suporte Caixa Polimérica LD

R-389-B

Suporte Caixa Polimérica LE



R-255-A

Suporte Caixa Ferramenta LD
(Linha R)

R-256-A

Suporte Caixa Ferramenta LE
(Linha R)

R-255-B

Reforço do Suporte LD

R-256-B

Reforço do Suporte LE

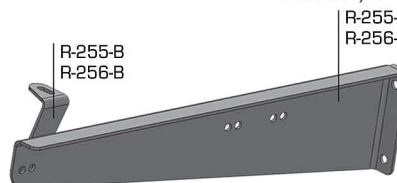

COMPATÍVEL COM: LINHA LIBRELATO

L-982-A

Suporte Caixa Ferramentas LD

L-982-B

Suporte Caixa Ferramentas LE



L-927-A

Suporte Caixa Ferramentas LD

L-927-B

Suporte Caixa Ferramentas LE

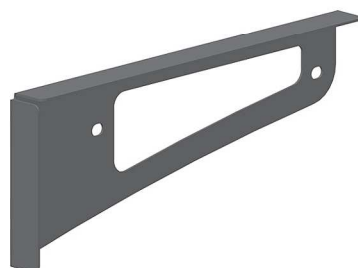

L-983-A

Suporte Caixa Mantimentos LD

L-983-B

Suporte Caixa Mantimentos LE



R-209-A

Conjunto Amarração de Carga
(Randon)

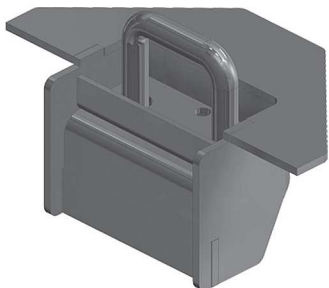

R-209-B

Flange de Amarração de Carga
(Randon)

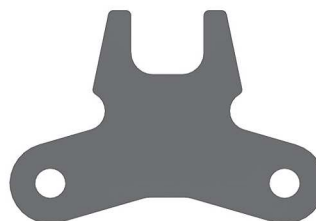

R-209-C

Reforço Amarração
Assoalho de Ferro
(Randon)



R-209-D

Reforço Travessa
Assoalho de Madeira
(Randon)



DIVERSOS

D-845

Gancho de Assoalho p/Amarração
de Carga Móvel

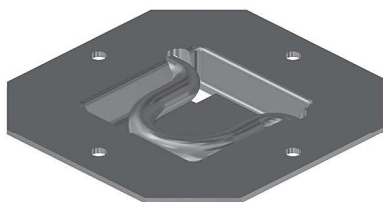

D-866

Chapa Passagem
Cinta Assoalho



D-865-A

Grampo da Cinta (100mm)

D-865-B

Grampo da Cinta (135mm)



COMPATÍVEL COM: LINHA RANDON

R-190

Para-lama Traseiro LD

R-191

Para-lama Traseiro LE



R-192

Para-lama Dianteiro LD

R-193

Para-lama Dianteiro LE



COMPATÍVEL COM: LINHA GUERRA

G-470

Para-lama Traseiro LD

G-471

Para-lama Traseiro LE



G-472

Para-lama Dianteiro LD

G-473

Para-lama Dianteiro LE



R-197-D

Suporte de Para-Lama (mod.Simples)
(espessura reduzida)



R-197-A

Suporte de Para-Lama
(mod.Original)



R-401

Suporte de Para-Lama
(mod.2020)



R-197-C

Suporte de Para-Lama "Universal"
(espessura reduzida)



G-478

Suporte de Para-Lama Bitrem Moderno

G-478-A

Suporte de Para-Lama Bitrem Moderno
(espessura reduzida)



L-987-A

Suporte Meio Para-Lama LD

L-987-B

Suporte Meio Para-Lama LE



L-954

Suporte de Para-Lama

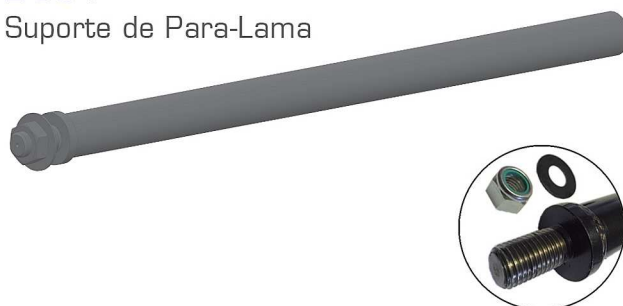

F-686

Suporte de Para-Lama

F-686-A

Suporte de Para-Lama
(espessura reduzida)

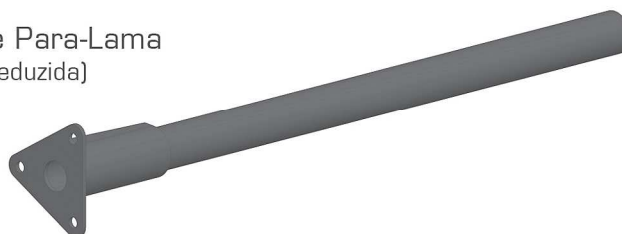

N-529

Suporte do Para-Lama

N-529-A

Suporte de Para-Lama
(espessura reduzida)



R-203

Suporte da Placa
(Compatível c/Linha Randon)



R-199

Suporte de Placa
200x173mm (Compatível c/Linha Randon)



G-439

Suporte de Placa
Modelo 2011 (Compatível c/Linha Guerra)

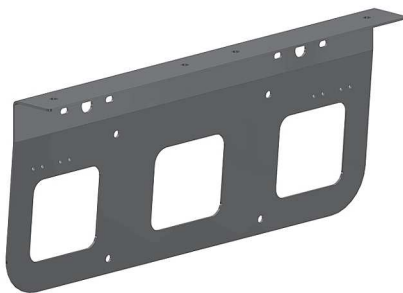

G-466

Suporte de Placa
(Compatível c/Linha Guerra)



N-602

Suporte da Placa
(Compatível c/Linha Noma)

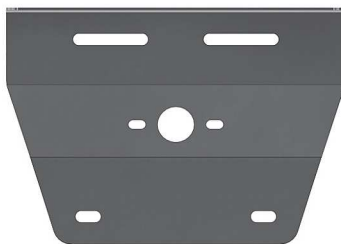

L-958

Suporte de Placa
(Compatível c/Linha Librelato)

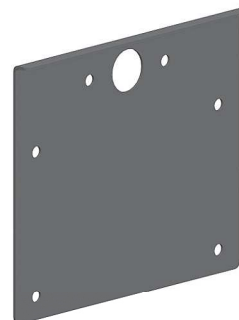

COMPATÍVEL COM: LINHA RANDON

R-394-A

Suporte Sinaleira Traseira LD (Dolly)

R-394-B

Suporte Sinaleira Traseira LE (Dolly)

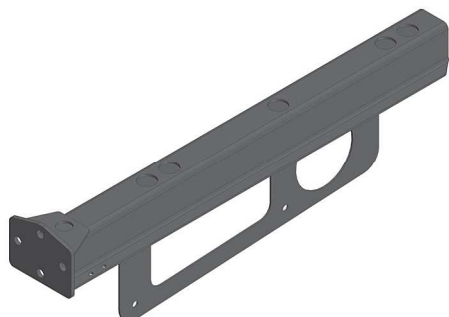

R-393

Suporte Sinaleira Dianteira (Dolly)



R-391

Suporte Lanterna Lateral
ABS



R-188

Suporte da Lanterna
Lateral

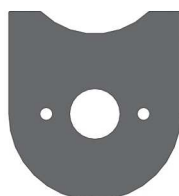

R-394-C

Reforço Fixação
Suporte (Dolly)



COMPATÍVEL COM: LINHA GUERRA

G-595

Suporte para Sinaleira
Modelo 2010

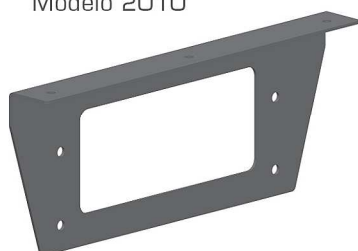

G-596

Suporte para Sinaleira Led
Modelo 2010



G-463-A

Suporte de Lanterna
Lateral (1 furo)



G-463-B

Suporte de Lanterna
Lateral (2 furos)

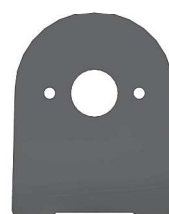

COMPATÍVEL COM: LINHA FACCHINI

F-707-A

Suporte Sinaleira Traseira LD (Dolly)

F-707-B

Suporte Sinaleira Traseira LE (Dolly)



F-706-A

Suporte Sinaleira Dianteira LD (Dolly)

F-706-B

Suporte Sinaleira Dianteira LE (Dolly)



F-703

Suporte Sinaleira



F-706-C

Suporte Fixação Sinaleira ABS (Dolly)



F-707-C

Suporte Fixação Sinaleira Traseira (Dolly)



F-708

Suporte Fixação Sinaleira de Seta (Diversos)



COMPATÍVEL COM: LINHA LIBRELATO

L-986-A

Suporte Sinaleira Traseira LD (Dolly)

L-986-B

Suporte Sinaleira Traseira LE (Dolly)



L-985-A

Suporte Sinaleira LD

L-985-B

Suporte Sinaleira LE



L-975

Suporte Sinaleira



COMPATÍVEL COM: LINHA NOMA

N-531

Suporte de lanterna Lateral



N-614

Suporte Sinaleira Traseira (Dolly)



D-855

Fixador Conjunto Aparelho
Levantamento Pé Mecânico (405mm)



D-857

Fixador Conjunto Aparelho
Levantamento Pé Mecânico (400mm)
(Guerra Moderno)



D-854

Fixador Conjunto Aparelho
Levantamento Pé Mecânico (330mm)
(Randon Antigo)



D-856

Fixador Conjunto Aparelho
Levantamento Pé Mecânico (265mm)
(Randon Moderno)

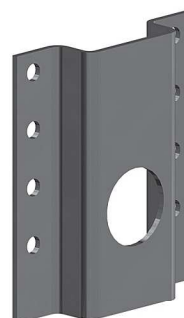

D-973

Bucha do Eixo da Transmissão
do Pé Mecânico

L-956

Conexão Elétrica Pneumática
(Suporte Mão Amiga)
(Linha Librelato)

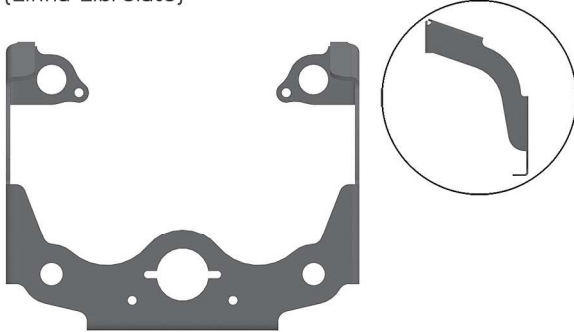

L-957

Conexão Elétrica Pneumática
(Suporte Mão Amiga)
(Linha Librelato / Horizon)

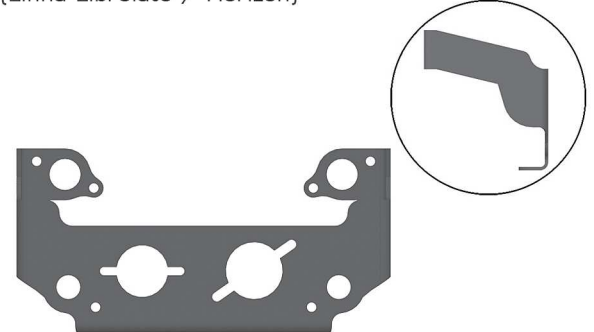

L-968

Engate Pneumático
(Linha Librelato)



N-541

Conexão Elétrica Pneumática
(Linha Noma)

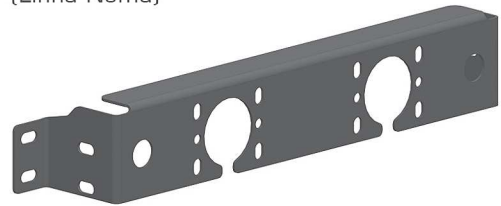

G-519

Conexão Elétrica Pneumática
(Baú / Linha Guerra)

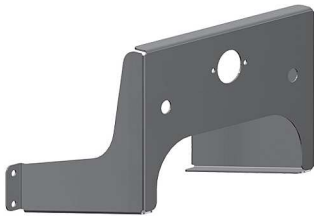

R-165

Conexão Elétrica Pneumática
(Linha Randon)



SDF-032

Engate Pneumático Metálico
(Baú Lonado Fachinni)

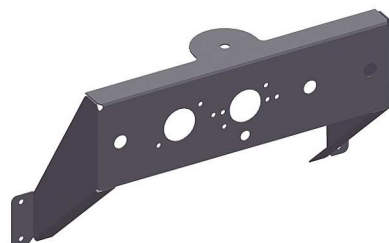

CA-019-A

Caixa da Articulação da Basculante Invertida Maior Completa (alt.400mm)

CA-019-B

Caixa da Articulação da Basculante Invertida Menor Completa (alt.250mm)



CA-001

Caixa da Articulação da Basculante Maior Completa (alt.400mm)

CA-002

Caixa da Articulação da Basculante Menor Completa (alt.250mm)

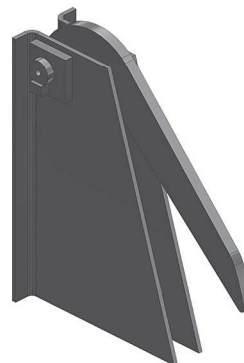

CA-003

Caixa da Articulação da Basculante Maior (alt.400mm)

CA-004

Caixa da Articulação da Basculante Menor (alt.250mm)

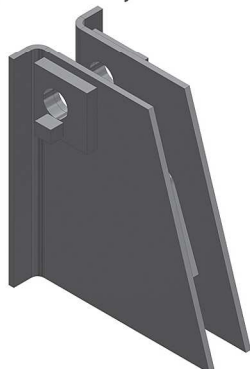

CA-030-A

C hapa da Articulação da Basculante LD

CA-030-B

Chapa da Articulação da Basculante LE



CA-005

Articulação da Tampa p/Basculante Longa - Bengala (comp.450mm)

CA-006

Articulação da Tampa p/Basculante Longa - Bengala (comp.330mm)

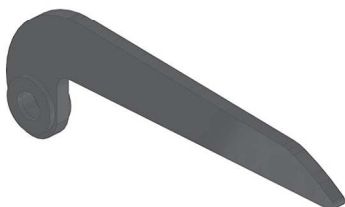

CA-035-A

Catraca do Suporte do Estepe LD

CA-035-B

Catraca do Suporte do Estepe LE

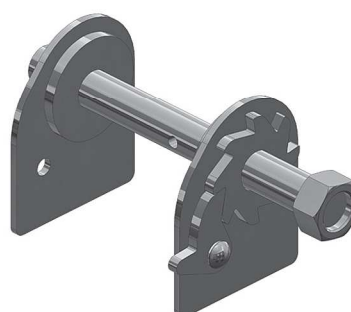

CA-009

Kit do Pino da Articulação



CA-007

Pino da Articulação da Tampa da Basculante



CA-009-A

Pino da Articulação (Ø49,8x143mm)



CA-008

Pino da Basculante (Ø45x180mm)



CA-029

Conjunto Pino Superior do Pistão da Basculante



CA-028

Conjunto Pino Inferior do Pistão da Basculante



CA-025

Conjunto Pino e Buchas da Articulação da Caçamba



CA-034

Suporte do Estepe da Caçamba



CA-015

Tranca da Tampa da Basculante LD
Mola Simples (gancho 16mm) - acompanha corrente

CA-016

Tranca da Tampa da Basculante LE
Mola Simples (gancho 16mm) - acompanha corrente



CA-021

Tranca da Tampa da Basculante LD
Mola Simples (gancho 9,35mm) - acompanha corrente

CA-022

Tranca da Tampa da Basculante LE
Mola Simples (gancho 9,35mm) - acompanha corrente



CA-014

Tranca da Tampa da Basculante
Mola Dupla (gancho 16mm) - acompanha corrente

CA-020

Tranca da Tampa da Basculante
Mola Dupla (gancho 9,53mm) - acompanha corrente

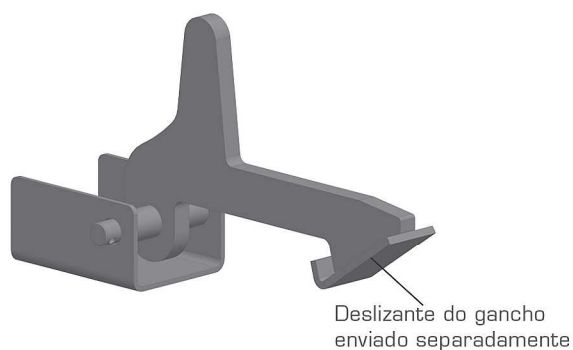

CA-018

Suporte de Estepe da basculante

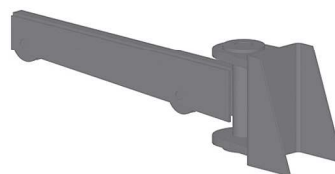

CA-031

Dobradiça Menor Superior da Tampa da Basculante

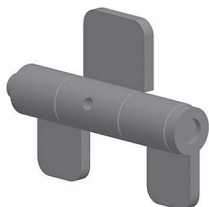

CA-026

Gancho Traseiro da Caçamba



CA-032

Dobradiça Maior Lateral da Tampa Traseira da Basculante

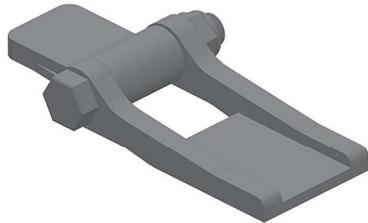

CA-033

Dobradiça da Articulação do Parachoque da Basculante

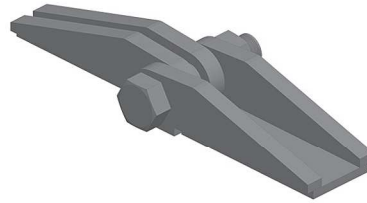

CA-010

Dobradiça de Caçamba e Parachoque (reforçada) acompanha parafuso M20

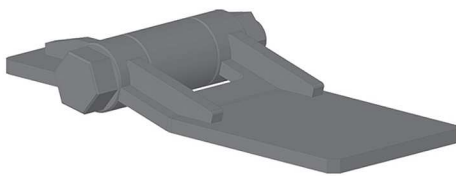

CA-013

Bucha do Pino p/Basculante (70mm)
Ø interno 45,5mm

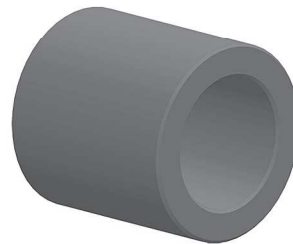

CA-011

Mancal do Pino da Caçamba (6,35mm)
Ø interno 45,5mm

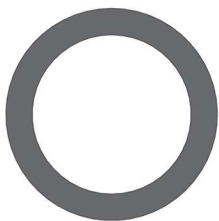

CA-012

Mancal do Pino da Basculante (18mm)
Ø interno 45,5mm

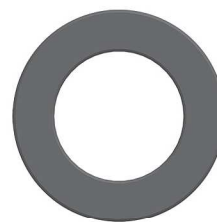

CA-017

Mancal do Pino da Basculante
(chapa 16mm)

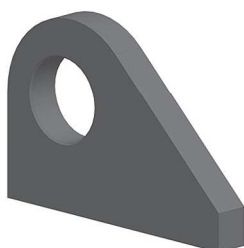

CA-027

Mancal Superior do Pino do Pistão p/Caçamba Basculante



PRESILHAS / TRAVAS DE ESTEPE

D-825
Presilha da Tampa

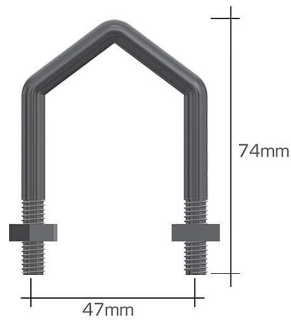

D-826
Presilha da Tapa Bitrem



D-827
Presilha da Cinta



R-248
Presilha da Tapa (73mm)

R-248-A
Presilha da Tapa (82mm)

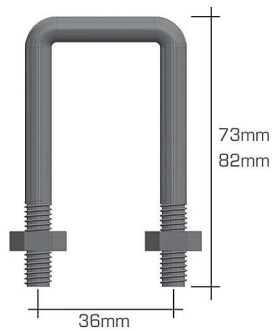

G-601
Presilha da Tapa - mod.2011

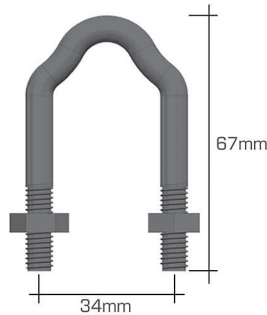

G-600
Presilha - mod.2011

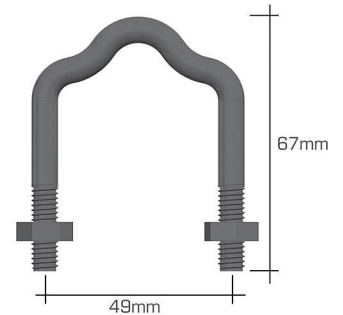

D-835-A
Conjunto Trava de Estepe - Roda Raiada (490mm)

D-835-01
Trava de Estepe Avulsa - Roda Raiada (490mm)

D-835-B
Conjunto Trava de Estepe - Roda Raiada (540mm)

D-835-02
Trava de Estepe Avulsa - Roda Raiada (540mm)

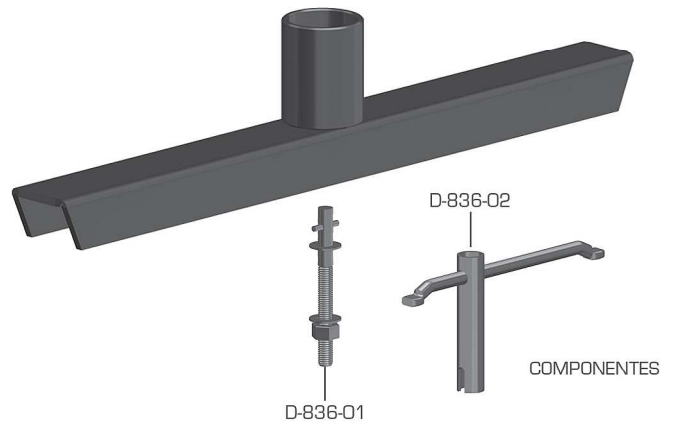

D-834
Conjunto Trava de Estepe - Roda Disco (330mm)

D-834-01
Trava de Estepe Avulsa - Roda Disco (330mm)



D-934
Parafuso Trava de Estepe



D-837-B

Gancho de Corda - s/zincagem
(Ø12mm)



D-838-A

Fixador da Tampa (porca 3/4")

D-838-B

Fixador da Tampa (porca 5/8")

D-838-C

Fixador da Tampa (porca 7/8")

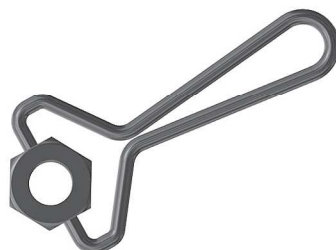

D-831

Presilha do Fueiro
(24mm)

S-721

Presilha do Fueiro Schiffer
(20mm)



D-832

Pino do Fueiro "Mamica"



D-833

Rebite de Corda



D-870

Joaninha da Tampa



D-830

Correntinha p/Pino



D-829-A

Pino de Tampa s/Corrente (Ø6mm)

D-829-B

Pino de Tampa s/Corrente (Ø7mm)

D-829-C

Pino de Tampa s/Corrente (Ø8mm)



D-828-A

Pino de Tampa c/Corrente (Ø6mm)

D-828-B

Pino de Tampa c/Corrente (Ø7mm)

D-828-C

Pino de Tampa c/Corrente (Ø8mm)



D-829-D

Pino de Tampa (Ø6mm)
Ponta Torta



D-828-E

Pino de Tampa c/Corrente (Ø6mm)
Ponta Torta



G-483

Pino Quebra Dedo (Ø 8mm)



R-151

Pino Quebra Dedo (Ø 6mm)

G-483-B

Pino Quebra Dedo c/Cinta Plástica (Ø 8mm)

R-151-B

Pino Quebra Dedo c/Cinta Plástica (Ø 6mm)



G-483-C

Pino Quebra Dedo c/Cinta de Aço (Ø 8mm)

R-151-C

Pino Quebra Dedo c/Cinta de Aço (Ø 6mm)



R-272

Conjunto Trava Rolete Patim

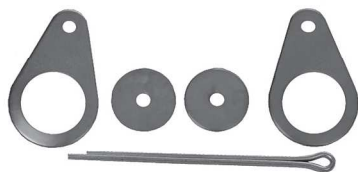

G-486

Aranha de Assoalho (Guerra)



G-483-A

Pino Quebra Dedo c/Corrente (Ø 8mm)

R-151-A

Pino Quebra Dedo c/Corrente (Ø 6mm)



D-844

Cinta Plástica Avulsa



D-841

Cinta de Aço Avulsa
(Ø1,5x190mm)



R-146

Grampo do Tombador (Ø 4mm)



R-201

Aranha de Assoalho (Randon)



D-824-A

Conjunto Engate da Corrente
(Sem Corrente Lisa)



D-824-04

Corrente Avulsa - 1300mm
(Para Engate de Corrente)



D-824-B

Conjunto Engate da Corrente
(Com "S" e Argola)



D-824-01

Engate da Corrente

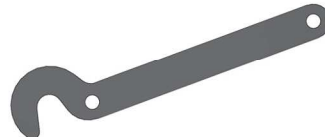

D-824-02

Argola



D-824-03

"S"



D-801

Conjunto Engate da
Corrente Truck

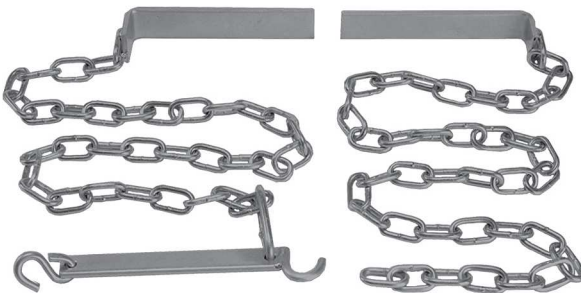

D-801-01

Engate da Corrente Truck



D-801-02

Chapinha Fixadora da Corrente

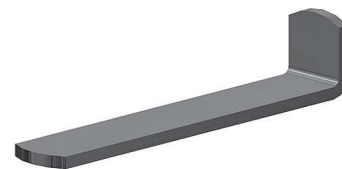

R-230

Engate da Corrente Linha "R"
(Randon)

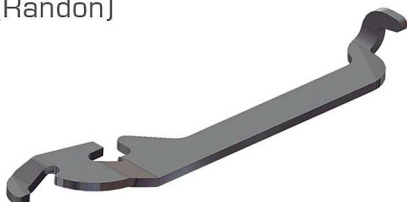

D-801-03

Fixador da Corrente
"Maial"



D-850

Engate Fêmea Krone
(135mm)



D-813

Dobradiça de Pressão Traseira LD (s/gancho)

D-814

Dobradiça de Pressão Traseira LE (s/gancho)

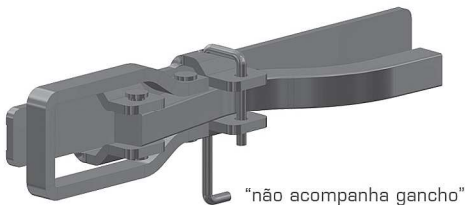

D-815

Dobradiça de Pressão Dianteira LD (s/gancho)

D-816

Dobradiça de Pressão Dianteira LE (s/gancho)

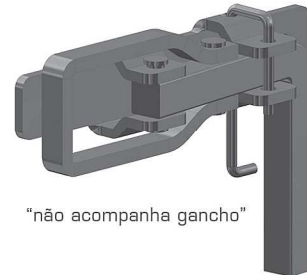

D-817

Gancho da Dobradiça de Pressão

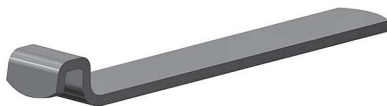

D-842

Dobradiça de Basculante

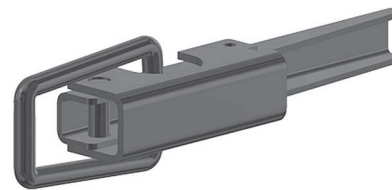

D-843

Engate Dobradiça de Basculante



D-818

Dobradiça da Tampa
Curta - soldada (110mm)

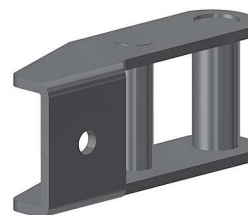

D-871

Suporte p/Botijão de Gás da Carreta



D-840

Gancho Rebocador Traseiro



G-506

Chapinha da Presilha da Tampa



D-822-A

Calço da Longarina (55x65mm)

D-822-B

Calço da Longarina (60x70mm)



D-841-A

Conchinha c/Pino (Ø 5/8")

D-841-B

Conchinha c/Pino (Ø 1/2")

D-841-C

Capa da Conchinha



RE-01

Suporte Macho (122mm)



RE-02

Suporte Macho (311mm)



RE-03

Suporte Fêmea (352mm)



D-807-A

Arruela Encosto Tubless (furo Ø38,5mm)

D-807-B

Arruela Encosto Tubless (furo Ø42,0mm)



D-891-A

Suporte de Lona (1500mm)

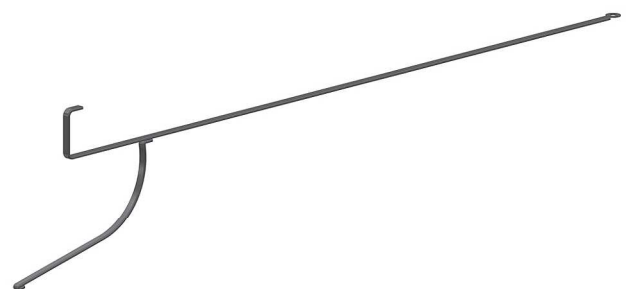

D-872

Dispositivo de Amarração de Carga (50mm)

D-873

Dispositivo de Amarração de Carga (55mm)

D-874

Dispositivo de Amarração de Carga (60mm)

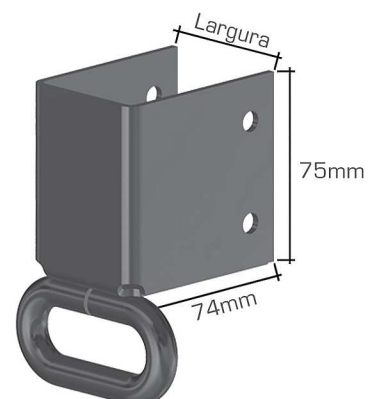

SC-854-A

Sobre Chassi (2100mm)

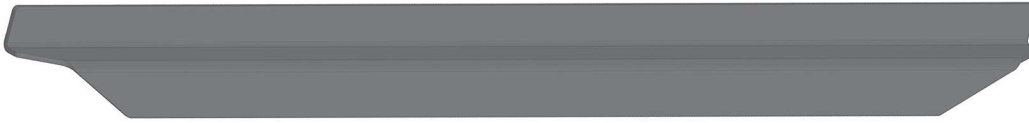

SC-857-A

Tubo Reto Para-Lama do Cavalo (2440mm)

Obs. Acompanha tampas Plásticas

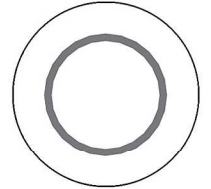

SC-858-A

Tubo Curvo Para-Lama do Cavalo (2435mm)

Obs. Acompanha Tampas Plásticas

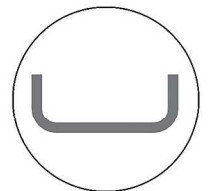

SC-859-A

Perfil "U" Para-Lama do Cavalo (2445mm)



SC-860-A

Abraçadeira Para-Lama do Cavalo



SC-861-B

Reforço Abraçadeira Para-Lama do Cavalo

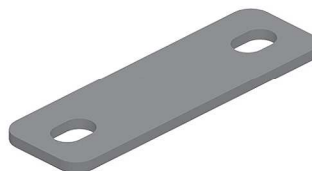

SC-861-C

Reforço Abraçadeira Para-Lama do Cavalo (com porca soldada)



SC-855-A

Mesa 5ª Roda Scania 113
664x960mm

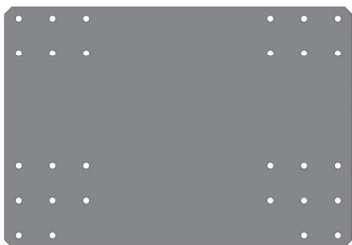

SC-856-A

Mesa 5ª Roda Scania 124
664x960mm

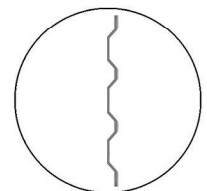
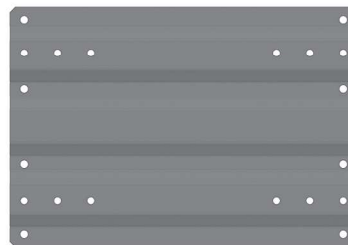

SC-863-A

Mesa 5ª Roda Scania
784x960mm



SC-857-02

Tampa Plástica do Tubo (Para-Lama do Cavalo)



VL-001

Perfil Lateral Fixação 5ª Roda



VL-002

Mesa 5ª Roda Volvo

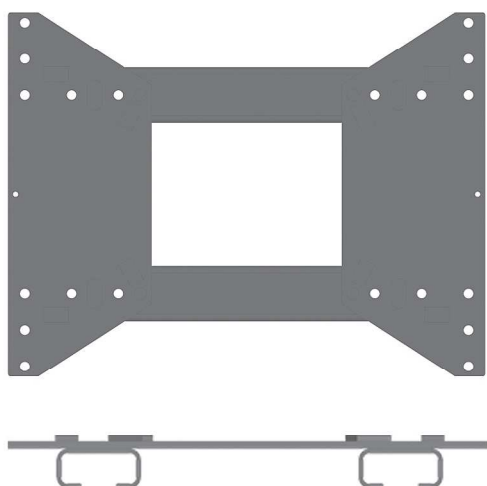

D-1004

Boca de Graneleira em Nylon (Universal)



R-397

Tampa Fueiro Arco de Lona
95mm



R-398

Tampa Fueiro Arco de Lona
145mm



R-383-A

Tampa do Fueiro Traseiro LD

R-383-B

Tampa do Fueiro Traseiro LE



R-386-A

Tampa do Frontal LD (mod.2006)

R-386-B

Tampa do Frontal LE (mod.2006)



R-382

Tampa do Fueiro Lateral
Antigo



R-385

Tampa do Fueiro Lateral
(mod.Largo)



R-396

Tampa Traseira do
Protetor Lateral



R-384

Tampa do Fueiro Lateral
(mod.2006)



R-395

Peça da Balança



R-206-04-A

Fechamento do Parachoque LD

R-206-04-B

Fechamento do Parachoque LE



R-381

Tampa da Vigüeta



R-399

Tucho Lateral



R-155

Apoio da Vigüeta



G-611

Boca de Graneleira em Nylon



G-586

Tampa do Fueiro Lateral (Antigo)



G-588

Tampa do Fueiro Lateral



G-552-A

Tampa do Fueiro Dianteiro c/Friso LD

G-552-B

Tampa do Fueiro Dianteiro c/Friso LE



G-587-A

Tampa do Fueiro Traseiro LD

G-587-B

Tampa do Fueiro Traseiro LE



G-551-A

Tampa do Fueiro Traseiro c/Friso LD

G-551-B

Tampa do Fueiro Traseiro c/Friso LE



G-550

Tampa do Fueiro Lateral c/Friso



COMPATÍVEL COM: LINHA GUERRA

G-548

Tampa do Parachoque



G-549

Suporte do Tira-Fino



G-589

Tampa Plástica Vigüeta Inferior
Tecno 10



G-585

Tampa da Vigüeta



COMPATÍVEL COM: LINHA NOMA

D-1004

Boca de Graneleira em Nylon (Universal)



N-615

Tampa da Vigüeta



N-616

Tampa do Fueiro
(a partir de 2008)



N-617

Tampa do Tira-Fino



D-1004

Boca de Graneleira em Nylon (Universal)



L-1020

Tampa da Vigueta Superior Horizon LD

L-1021

Tampa da Vigueta Superior Horizon LE



L-1018

Tampa da Vigueta Inferior Horizon LD

L-1019

Tampa da Vigueta Inferior Horizon LE



L-1024

Tampa do Fueiro Dianteiro Horizon LD

L-1025

Tampa do Fueiro Dianteiro Horizon LE



L-1022

Tampa do Fueiro Traseiro Horizon LD

L-1023

Tampa do Fueiro Traseiro Horizon LE



L-1017

Tampa do Tira-Fino



L-1026

Tampa do Fueiro Lateral Horizon



D-1004

Boca de Graneleira em Nylon (Universal)



D-970

Calço Plástico Tira-Fino da Carreta



D-971

Tampa do Tira-Fino Tritubular (Fixação Interna)



D-839-01

Tampa do Tira-Fino (Fixação Interna) (Guerra)



D-972

Tampa de Borracha Ø 8mm



D-1005

Tampa de Borracha Ø 11mm



D-1006

Tampa de Borracha Ø 27mm



D-844

Cinta Plástica



D-1015

Corda Elástica Preta Lisa 35cm

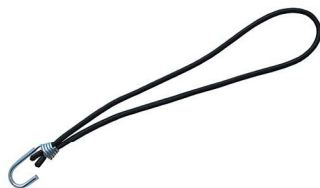

D-1016

Suporte Tampa Traseira Carreta Graneleira





D-1009

Conjunto Graneleiro Fueiro 3,9mt



D-1007

Conjunto Graneleiro 3mt - 3ton

D-1008

Conjunto Graneleiro 3mt - 1,5ton

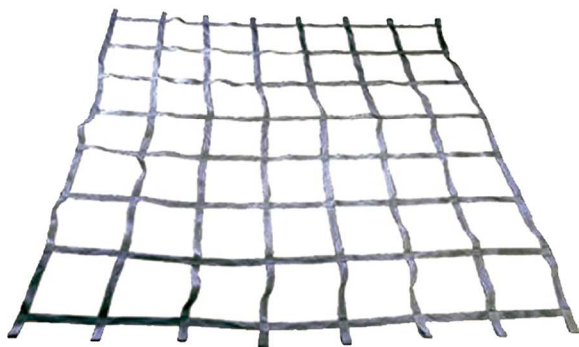

D-1010

Rede Contenção de Carga c/Olhal
3ton. 3x3mt 36x36cm

D-1011

Rede Contenção de Carga c/Olhal
3ton. 3x5mt 36x36cm

D-1012

Rede Contenção de Carga c/Olhal
3ton. 3x3mt 25x25cm

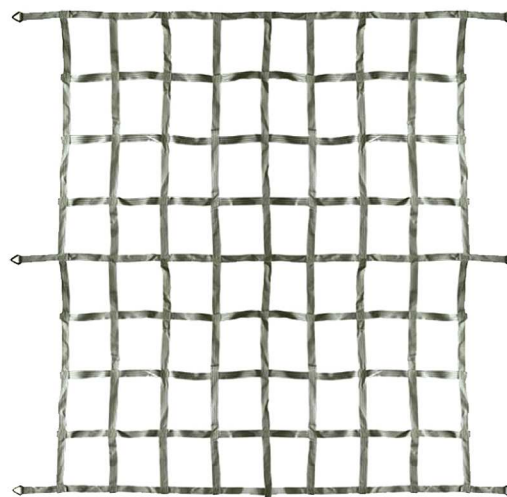

D-1013

Rede Contenção de Carga c/Gancho
3ton. 3x3mt 30x30cm

D-1014

Rede Contenção de Carga c/Gancho
3ton. 3x5mt 30x30cm

PL-010

Placa de Alumínio Randon Antiga - Preta
(0,07x90x425mm)



PL-002

Placa de Alumínio Guerra - Azul
(0,07x100x475mm)



PL-001

Placa de Alumínio Guerra - Amarela
(0,07x100x475mm)



PL-003

Placa de Alumínio Guerra - Amarela
(0,07x100x480mm) - Mod. Novo



PL-007

Placa de Alumínio Librelato - Azul
(0,07x100x480mm)



PL-011

Placa de Alumínio Schiffer - Vermelha
(0,07x90x460mm)



PL-014

Placa de Alumínio Facchini - Vermelha
(0,07x85x365mm)



PL-016

Placa de Alumínio Noma
(0,07x90x430mm)



PL-009

Placa de Alumínio Randon Moderna - Preta
(0,07x100x480mm)



PL-006

Placa de Alumínio Guerra - Azul
(0,07x140x600mm)



PL-005

Placa de Alumínio Guerra - Amarela
(0,07x140x600mm)



PL-004

Placa de Alumínio Guerra - Amarela
(0,07x125x595mm) - Mod. novo



PL-008

Placa de Alumínio Librelato - Azul
(0,07x110x530mm)



PL-012

Placa de Alumínio Schiffer - Azul
(0,07x90x460mm)



PL-013

Placa de Alumínio Facchini - Vermelha
(0,07x130x600mm)



PL-015

Placa de Alumínio Noma
(0,07x130x590mm)



PL-017

Faixa Refletiva de Advertência
Veículo Longo



PL-018

Faixa Refletiva
do Para-Choque



PL-021

Faixa Refletiva
Lateral LD - Carreta

PL-022

Faixa Refletiva
Lateral LE - Carreta

PL-019

Faixa Refletiva
Lateral LD - Sider

PL-020

Faixa Refletiva
Lateral LE - Sider

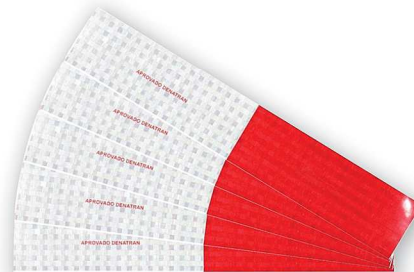



ROVALI
PEÇAS PARA TRUCKS E CARRETAS



LINHA SIDER

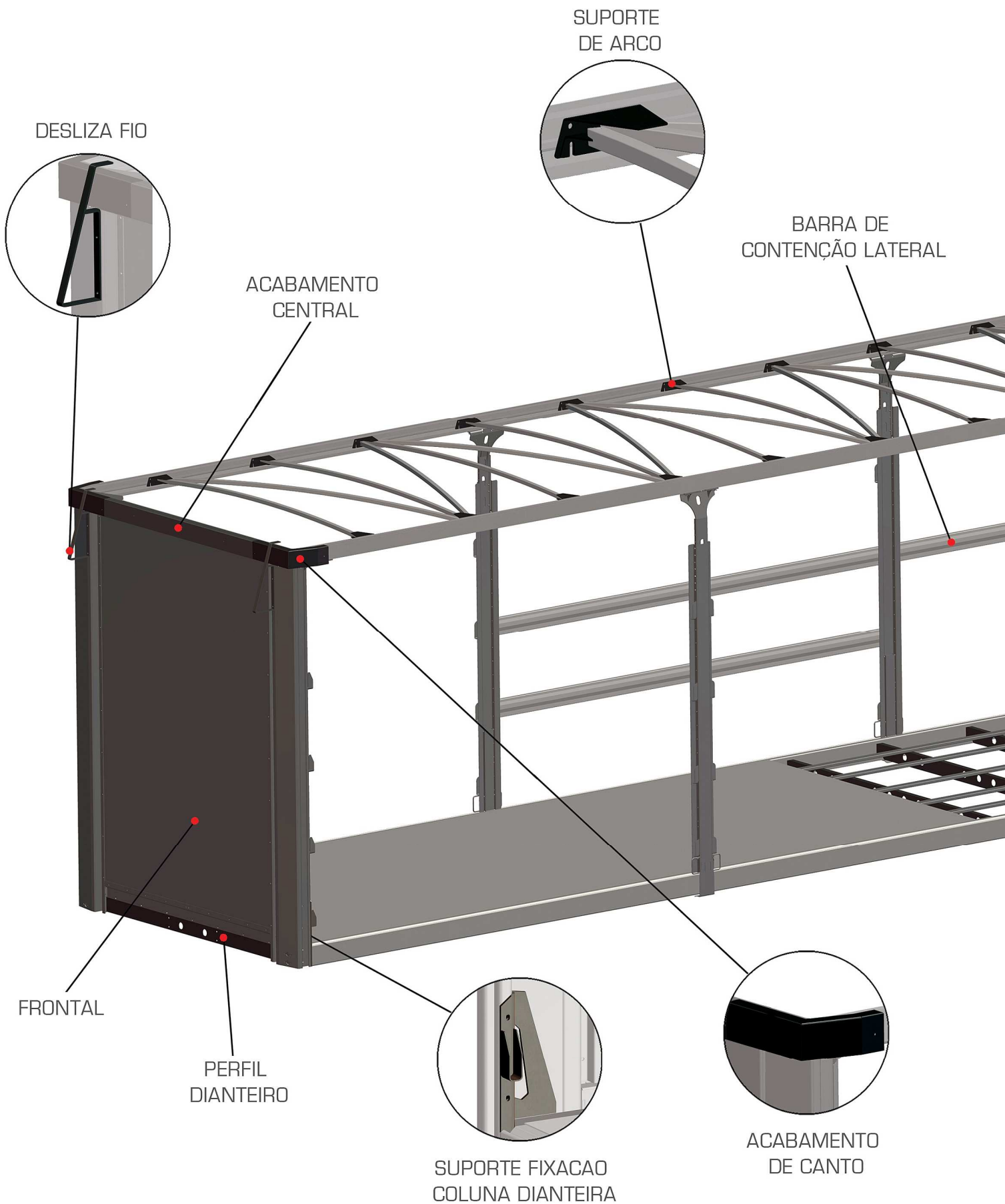

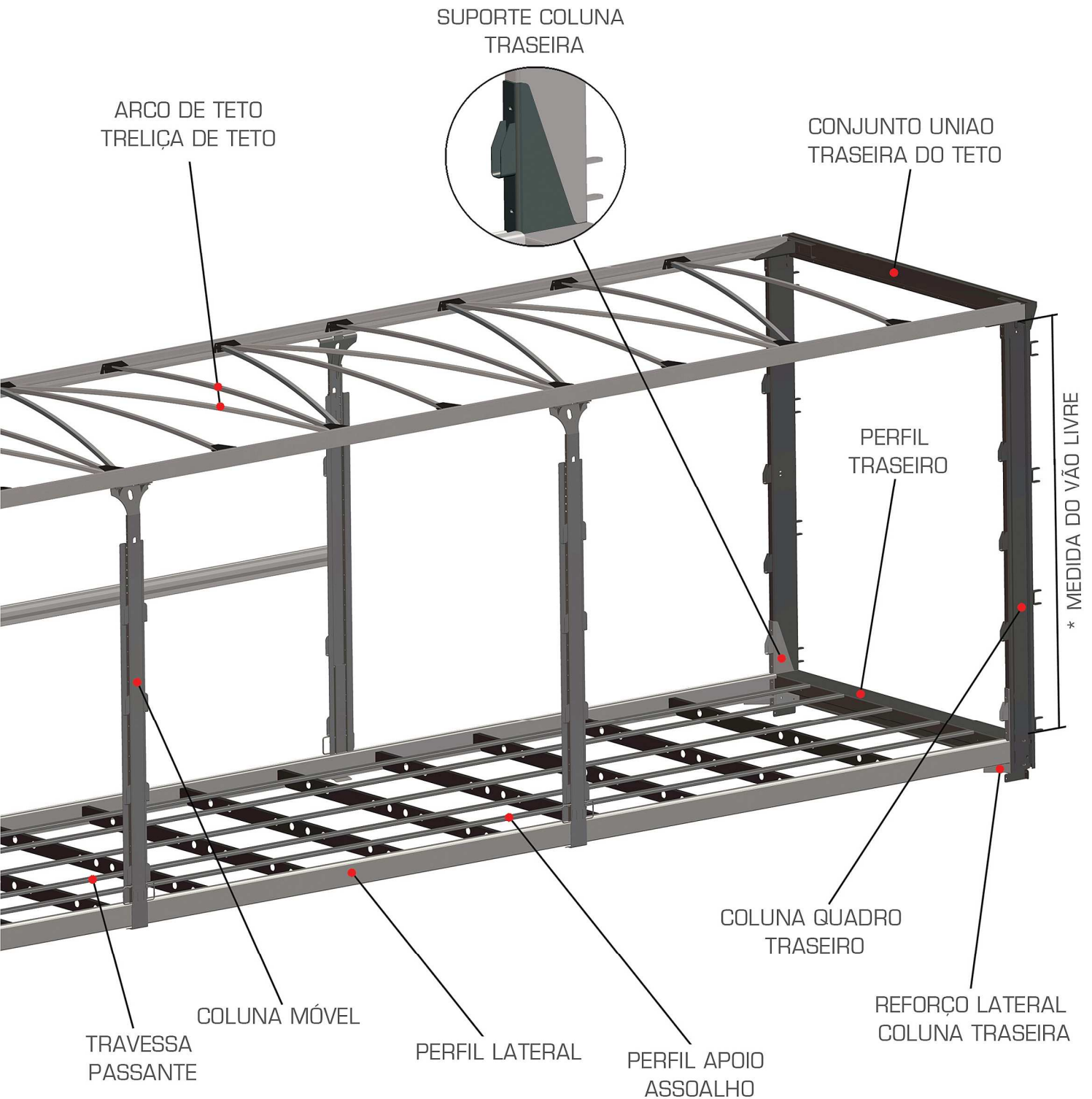

* OBSERVAR MEDIDA DO VÃO LIVRE

SDF-004

Kit Para Montagem do Frontal

COD.	MEDIDAS
SDF-004-A	2600 mm
SDF-004-B	2700 mm
SDF-004-C	2800 mm

SDF-018

Coluna Dianteira LD

COD.	MEDIDAS
SDF-018-A	2600 mm
SDF-018-B	2700 mm
SDF-018-C	2800 mm

SDF-019

Coluna Dianteira LE

COD.	MEDIDAS
SDF-019-A	2600 mm
SDF-019-B	2700 mm
SDF-019-C	2800 mm

SDF-020

Reforço "Z" Vertical LD

COD.	MEDIDAS
SDF-020-A	2600 mm
SDF-020-B	2700 mm
SDF-020-C	2800 mm

SDF-021

Reforço "Z" Vertical LE

COD.	MEDIDAS
SDF-021-A	2600 mm
SDF-021-B	2700 mm
SDF-021-C	2800 mm

SDF-022

Reforço Vertical

COD.	MEDIDAS
SDF-022-A	2600 mm
SDF-022-B	2700 mm
SDF-022-C	2800 mm

SDF-023

Perfil Fixação Central da Folha

COD.	MEDIDAS
SDF-023-A	2600 mm
SDF-023-B	2700 mm
SDF-023-C	2800 mm

SDF-024

Folha do Frontal

COD.	MEDIDAS
SDF-024-A	2600 mm
SDF-024-B	2700 mm
SDF-024-C	2800 mm

SDF-016

Travessa Inferior Frontal

SDF-017

Travessa Superior Frontal

* Medidas referentes ao vão livre do Sider.

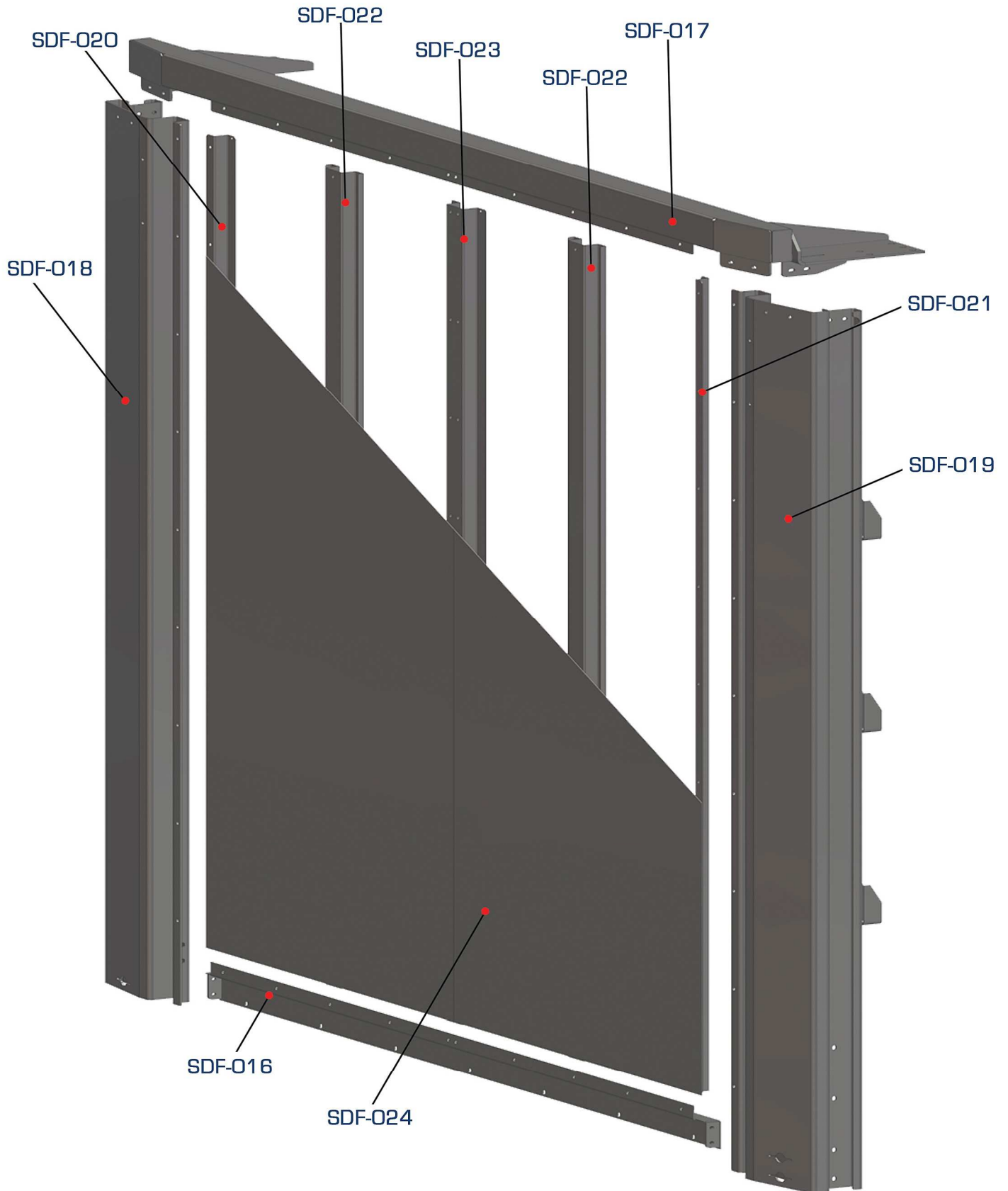



SDF-009
Perfil Dianteiro

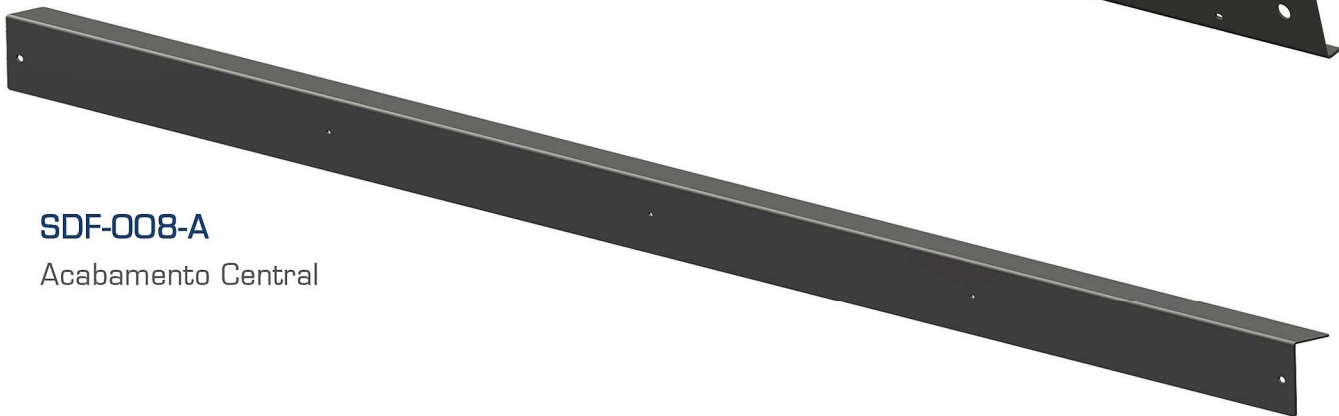

SDF-008-A
Acabamento Central



SDF-008-B
Acabamento de Canto LD

SDF-008-C
Acabamento de Canto LE



SDF-026
Desliza Fio

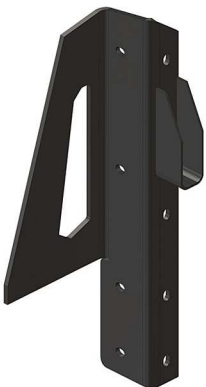

SDF-010-A
Suporte Fixação da Coluna Dianteira LD

SDF-010-B
Suporte Fixação da Coluna Dianteira LE

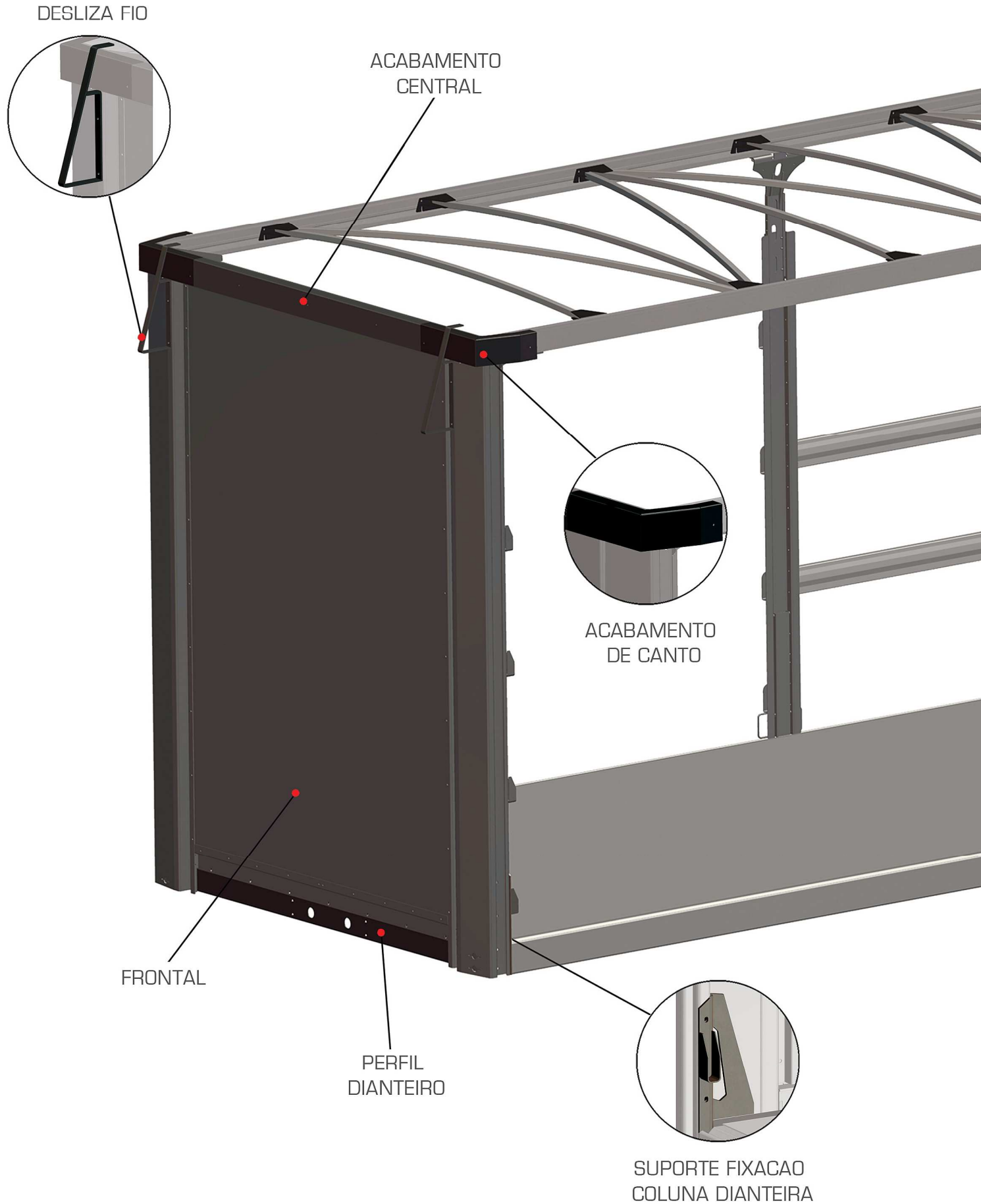

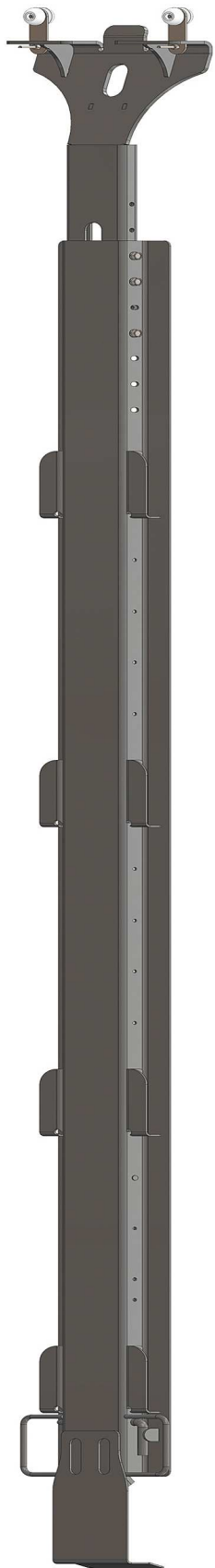

SDF-001

Coluna Móvel Lateral
(acompanha roletes)

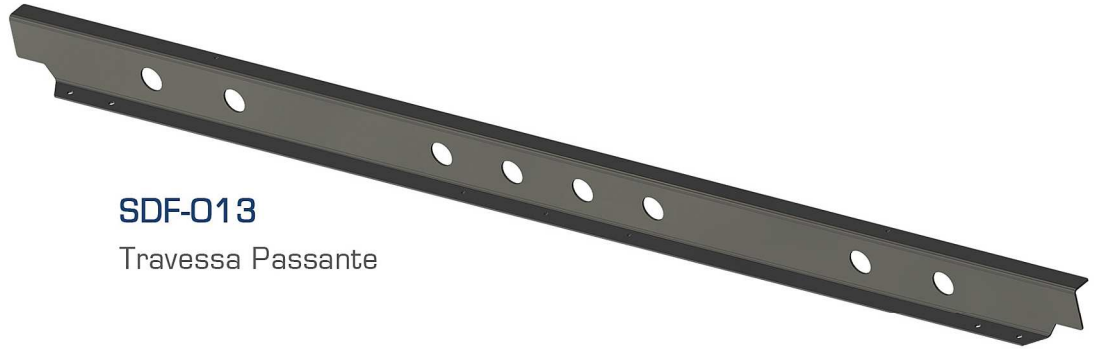

SDF-013

Travessa Passante



SDF-028-A

Arco de Teto 2390mm

SDF-028-B

Arco de Teto 2530mm



SDF-015

Rolete da Coluna Móvel



SDF-025-A

Suporte de Arco Inferior

SDF-025-B

Suporte de Arco Superior



SDF-029

Barra de Contenção



SDF-031

Perfil Lateral
(adaptação)



SDF-030

Perfil Apoio do Assoalho
3000mm

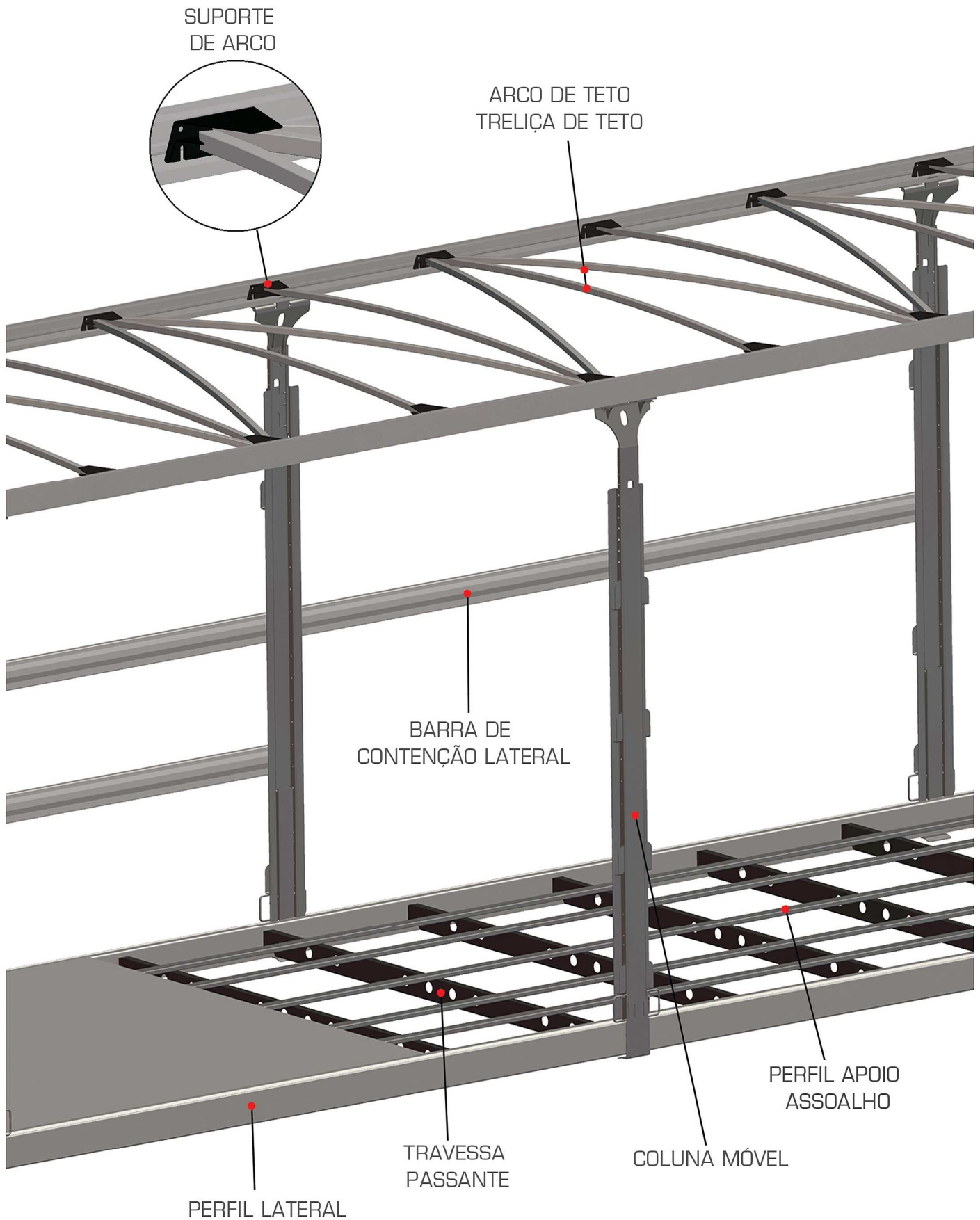

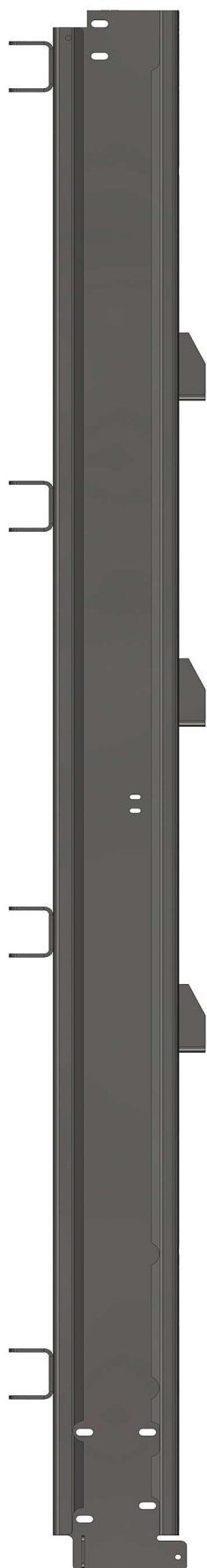

SDF-011

Conjunto União Traseira do Teto



SDF-012

Perfil Traseiro

SDF-002

Coluna Quadro Traseiro LD

COD.	MEDIDAS
SDF-002-A	2600 mm
SDF-002-B	2700 mm
SDF-002-C	2800 mm

SDF-003

Coluna Quadro Traseiro LE

COD.	MEDIDAS
SDF-003-A	2600 mm
SDF-003-B	2700 mm
SDF-003-C	2800 mm



SDF-014-A

Suporte Fixação Coluna Traseira LD

SDF-014-B

Suporte Fixação Coluna Traseira LE



SDF-027

Reforço Lateral Coluna Traseira

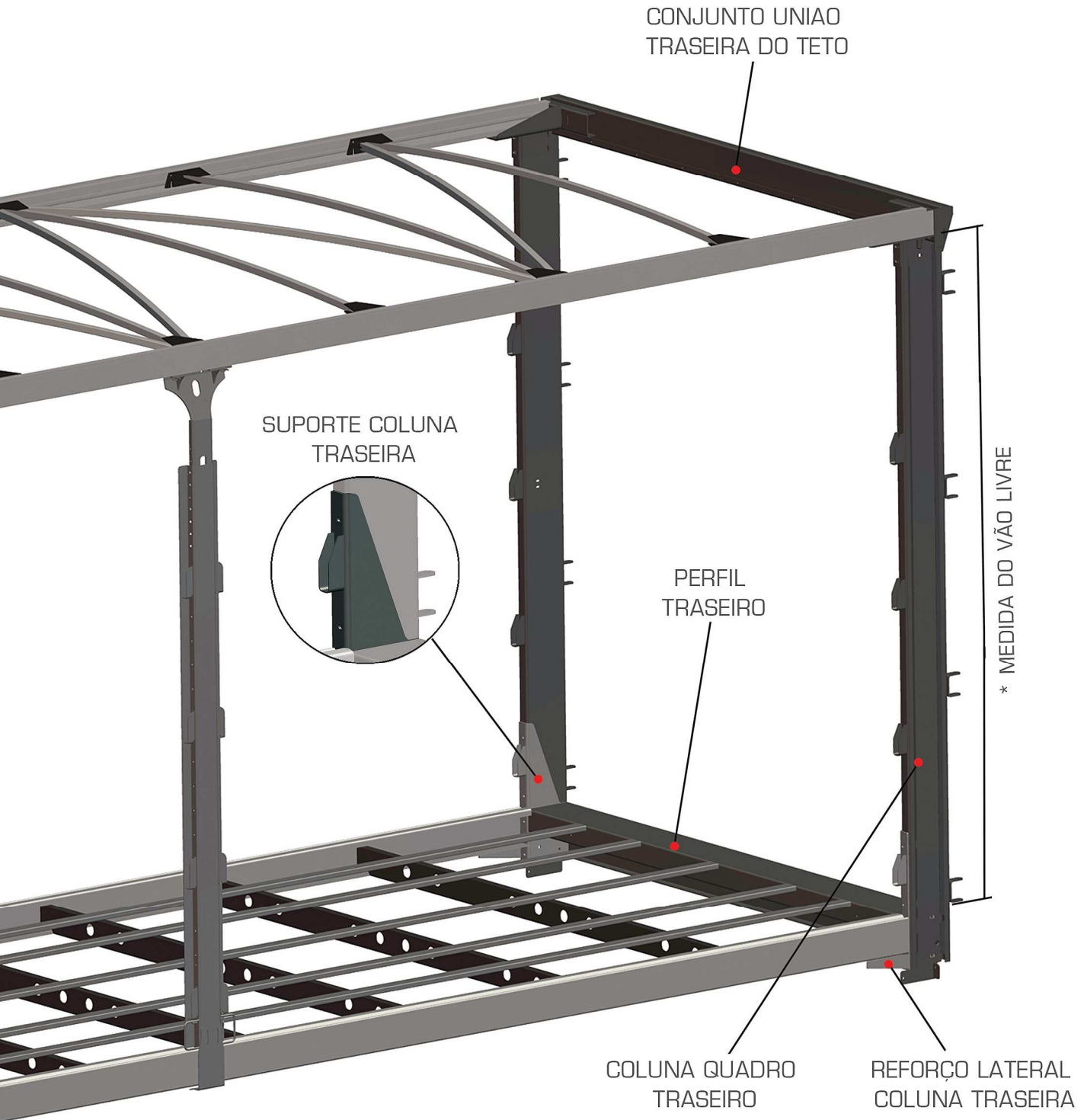

* OBSERVAR MEDIDA DO VÃO LIVRE

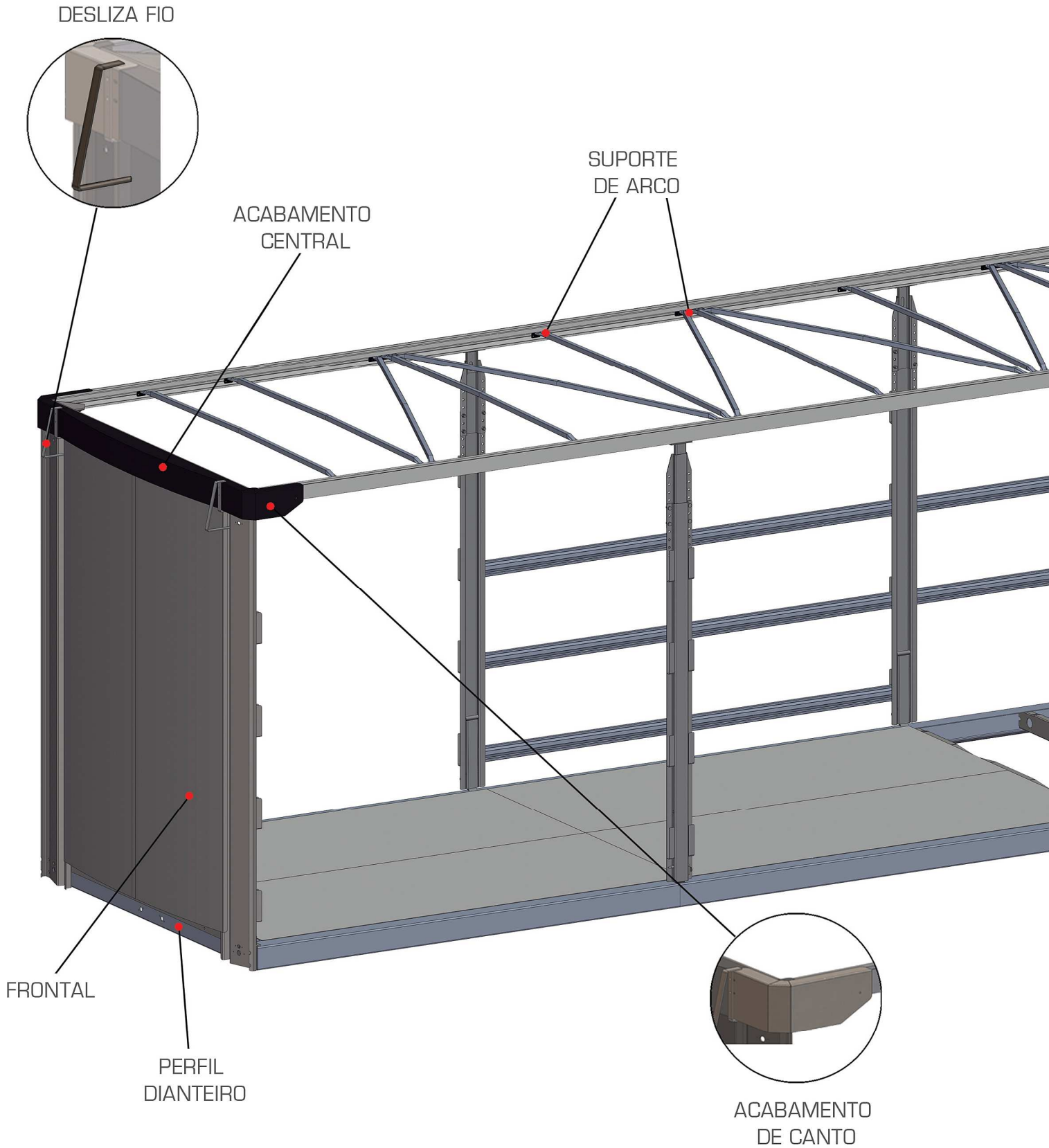

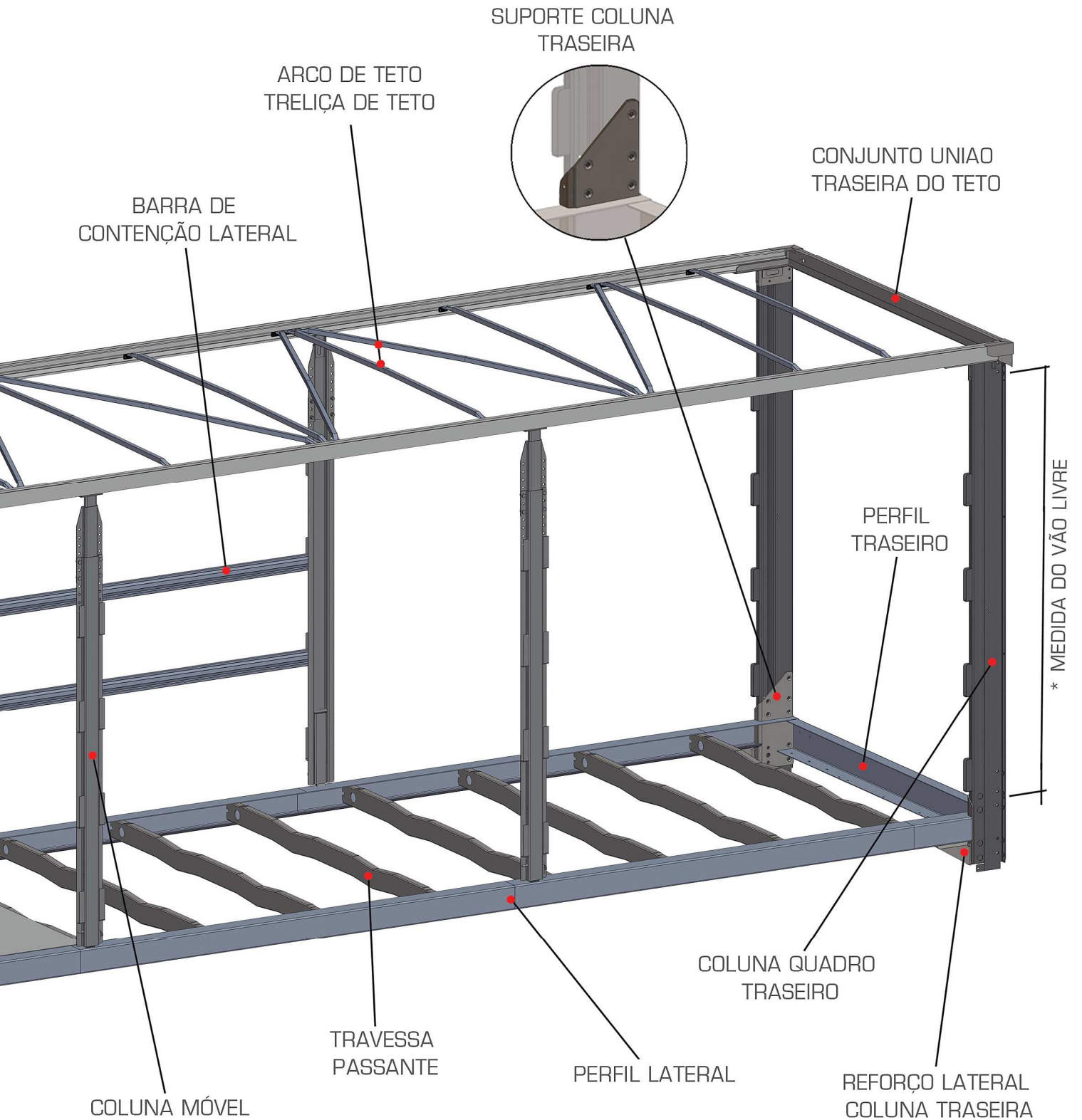

* OBSERVAR MEDIDA DO VÃO LIVRE

SDL-001

Kit Para Montagem do Frontal

COD.	MEDIDAS
SDL-001-A	2900 mm
SDL-001-B	2950 mm
SDL-001-C	3000 mm
SDL-001-D	3050 mm

SDL-002

Coluna Dianteira LD

COD.	MEDIDAS
SDL-002-A	2900 mm
SDL-002-B	2950 mm
SDL-002-C	3000 mm
SDL-002-D	3050 mm

SDL-003

Coluna Dianteira LE

COD.	MEDIDAS
SDL-003-A	2900 mm
SDL-003-B	2950 mm
SDL-003-C	3000 mm
SDL-003-D	3050 mm

SDL-008

Reforço Vertical LD

COD.	MEDIDAS
SDL-008-A	2900 mm
SDL-008-B	2950 mm
SDL-008-C	3000 mm
SDL-008-D	3050 mm

SDL-009

Reforço Vertical LE

COD.	MEDIDAS
SDL-009-A	2900 mm
SDL-009-B	2950 mm
SDL-009-C	3000 mm
SDL-009-D	3050 mm

SDL-007

Reforço Vertical Central

COD.	MEDIDAS
SDL-007-A	2900 mm
SDL-007-B	2950 mm
SDL-007-C	3000 mm
SDL-007-D	3050 mm

SDL-006

Folha do Frontal

COD.	MEDIDAS
SDL-006-A	2900 mm
SDL-006-B	2950 mm
SDL-006-C	3000 mm
SDL-006-D	6050 mm

SDL-004

Conjunto Perfil União Superior do Frontal

SDL-005

Conjunto Perfil União Inferior do Frontal

* Medidas referentes ao vão livre do Sider.

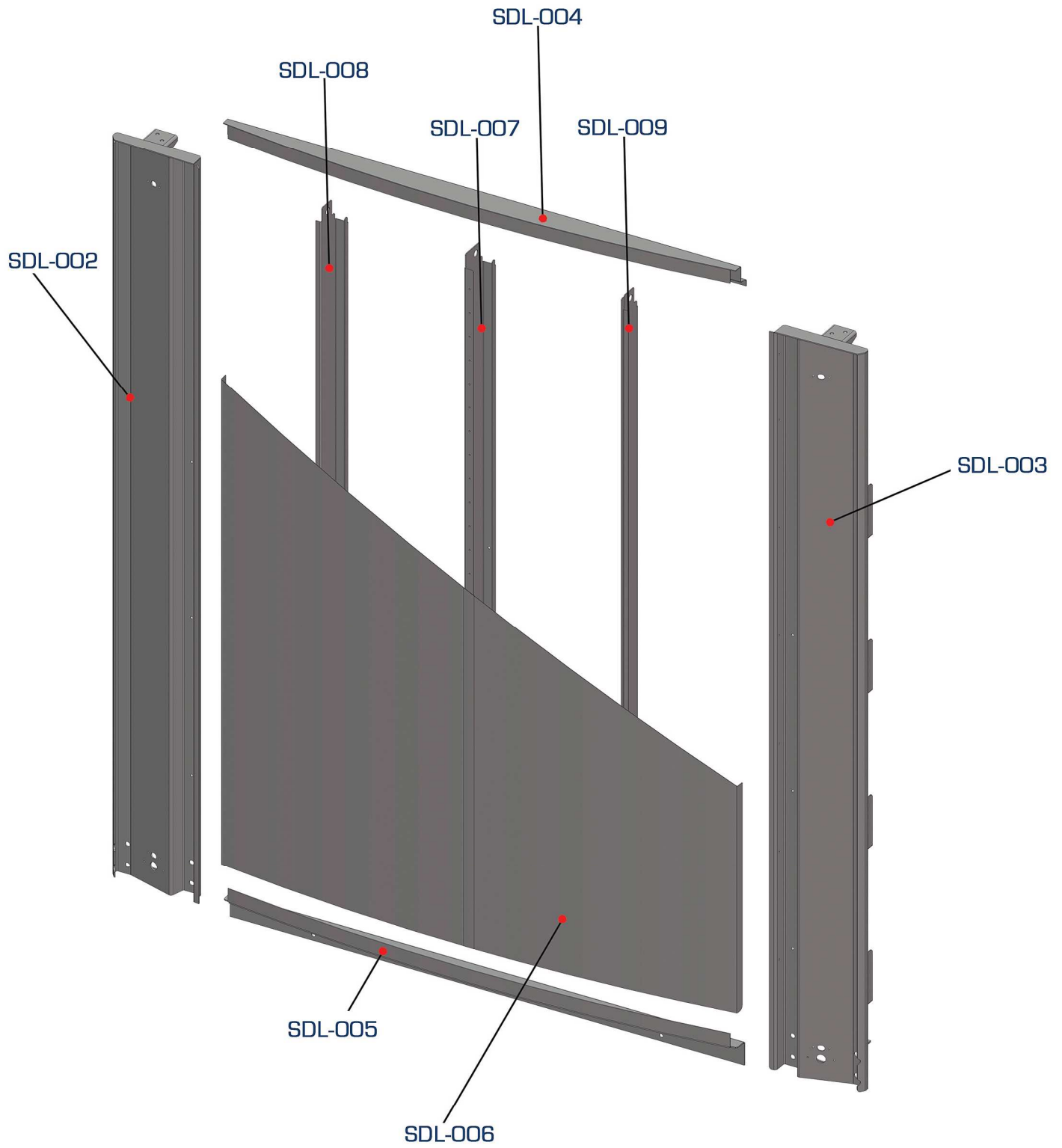



SDL-011

Conjunto Perfil União Dianteira do Teto

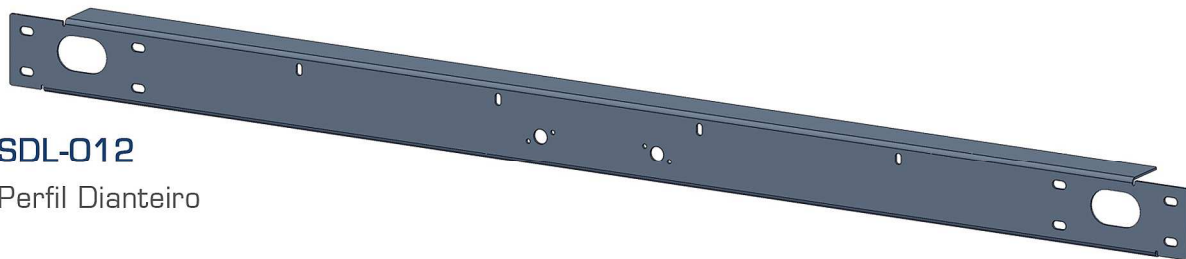

SDL-012

Perfil Dianteiro

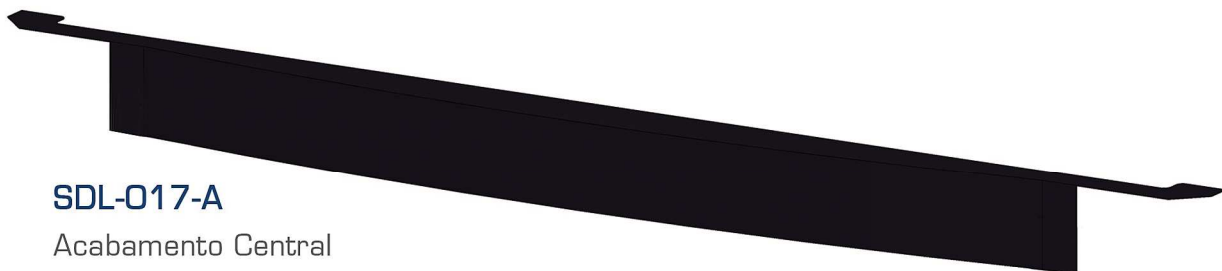

SDL-017-A

Acabamento Central



SDL-017-B

Acabamento de Canto LD

SDL-017-C

Acabamento de Canto LE

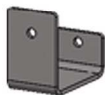

SDL-017-D

Suporte Acabamento Central

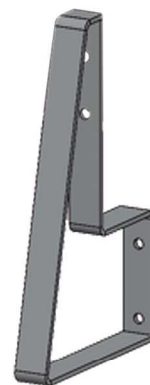

SDL-019

Desliza Fio

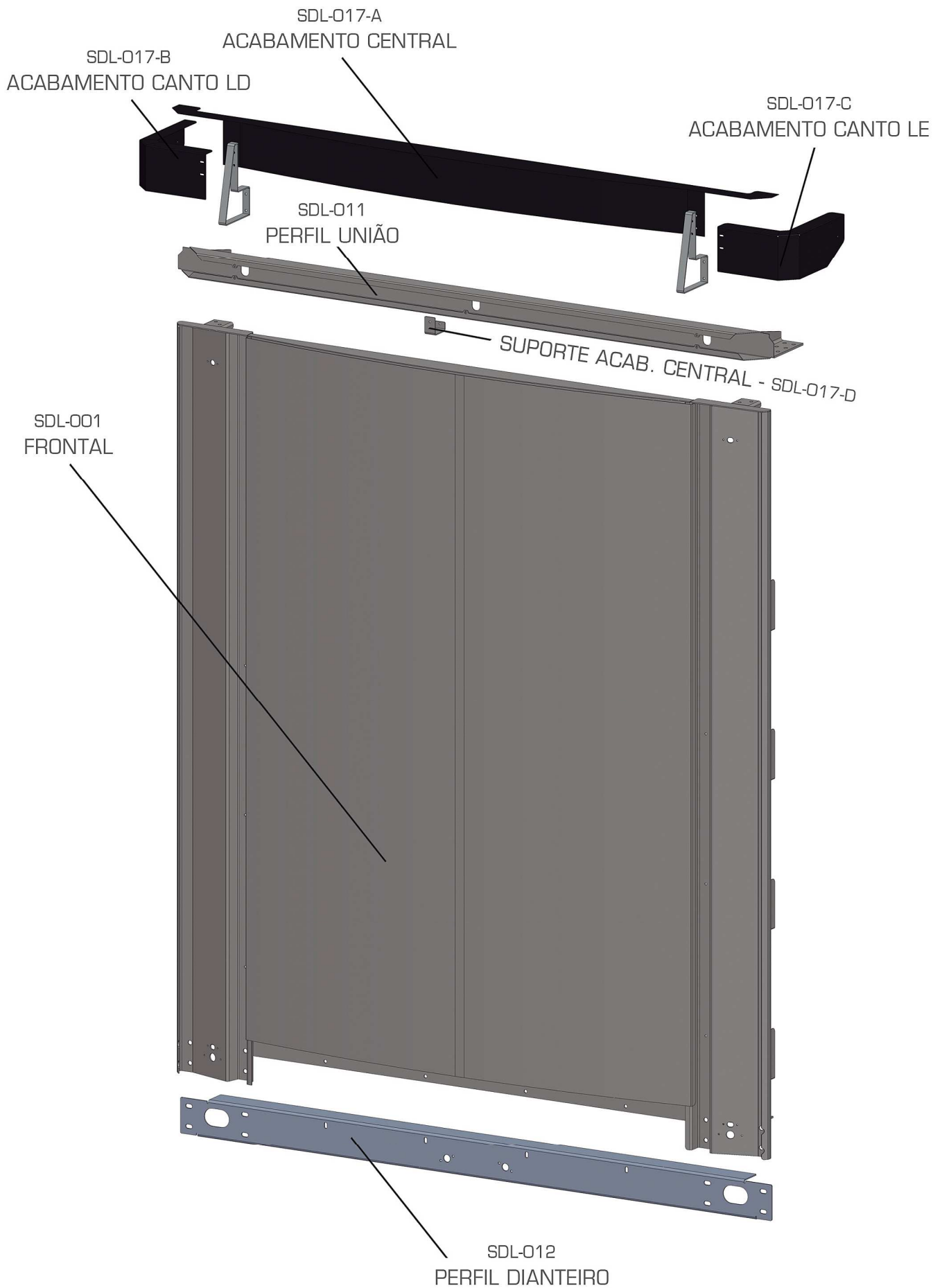

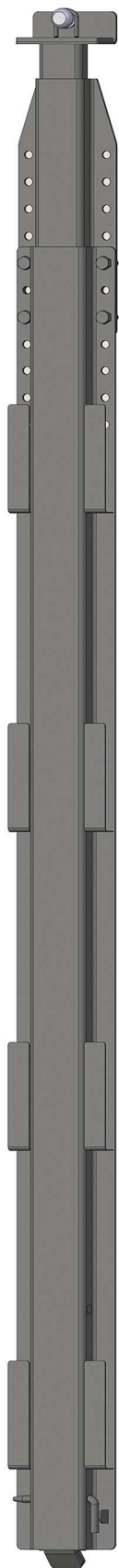

SDL-010

Coluna Móvel Lateral
(acompanha roletes)



SDL-023

Travessa Passante



SDL-024-A

Arco de Teto 2416mm

SDL-024-B

Arco de Teto 2616mm



SD-002

Roldana da Coluna Móvel



SDL-021

Perfil Lateral (adaptação)

SDL-021-A

Perfil Canto Traseiro LD

SDL-021-B

Perfil Canto Traseiro LE



SD-018

Deslizante Coluna Móvel



SDL-020-A

Suporte de Arco Simples

SDL-020-B

Suporte de Arco Duplo

SDL-020-C

Suporte de Arco Triplo



SDF-029

Barra de Contenção



SDL-025

Adaptador Coluna Móvel

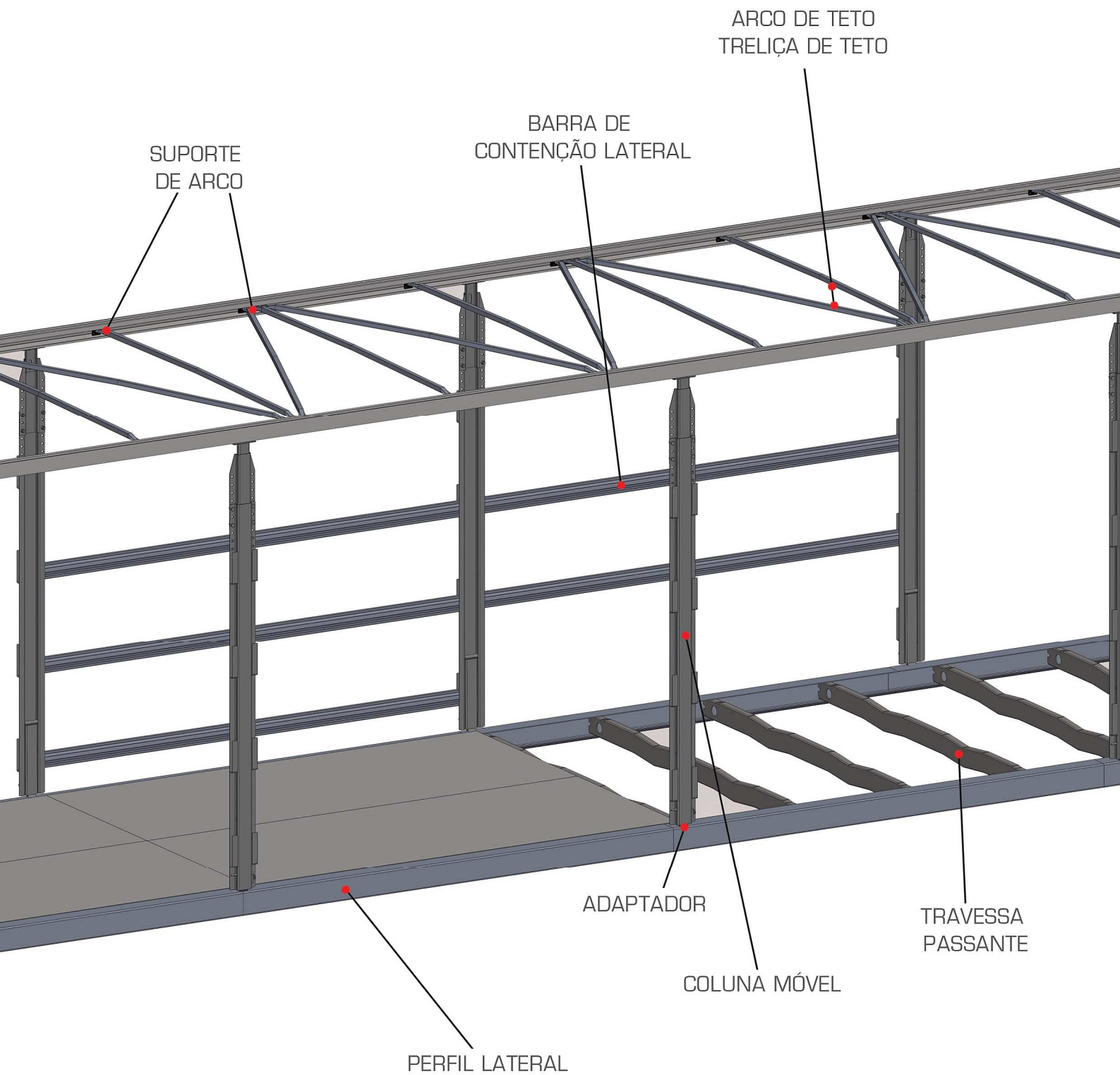



SDL-016

Conjunto União Traseira do Teto

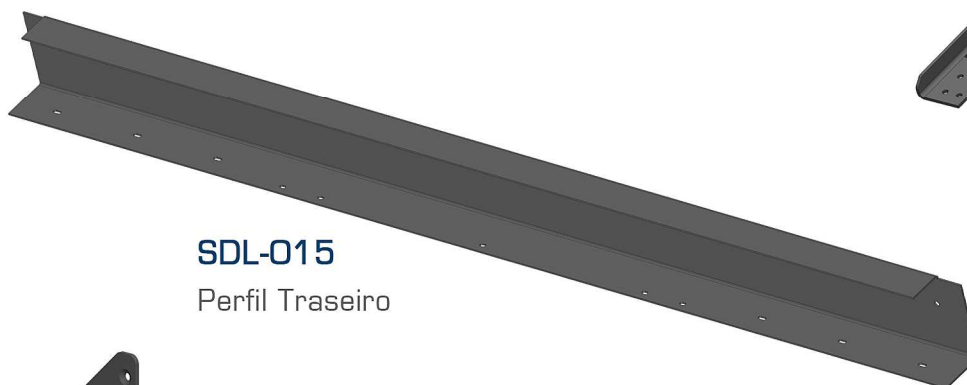

SDL-015

Perfil Traseiro



SDL-022-A

Suporte Fixação Coluna Traseira LD

SDL-022-B

Suporte Fixação Coluna Traseira LE

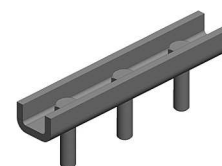

SDL-026

Fixador do Perfil

SDL-014

Coluna Quadro Traseiro LD

COD.	MEDIDAS
SDL-014-A	2900 mm
SDL-014-B	2950 mm
SDL-014-C	3000 mm
SDL-014-D	3050 mm

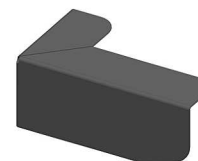

SDL-018-A

Acabamento Traseiro do Teto LD

SDL-018-B

Acabamento Traseiro do Teto LE

SDL-013

Coluna Quadro Traseiro LE

COD.	MEDIDAS
SDL-013-A	2900 mm
SDL-013-B	2950 mm
SDL-013-C	3000 mm
SDL-013-D	3050 mm



SDL-022-C

Reforço Lateral Coluna Traseira LD

SDL-022-D

Reforço Lateral Coluna Traseira LE

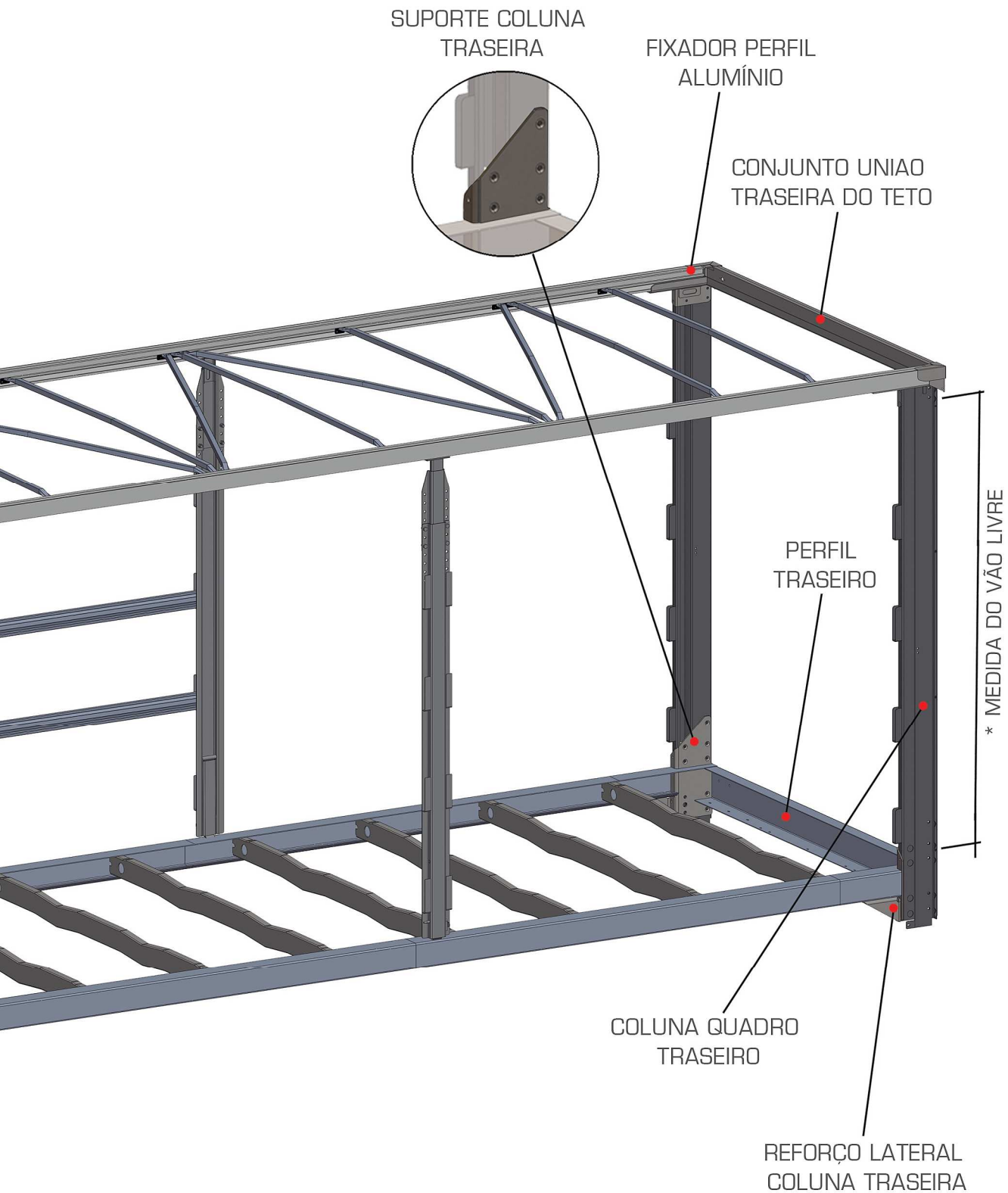

* OBSERVAR MEDIDA DO VÃO LIVRE

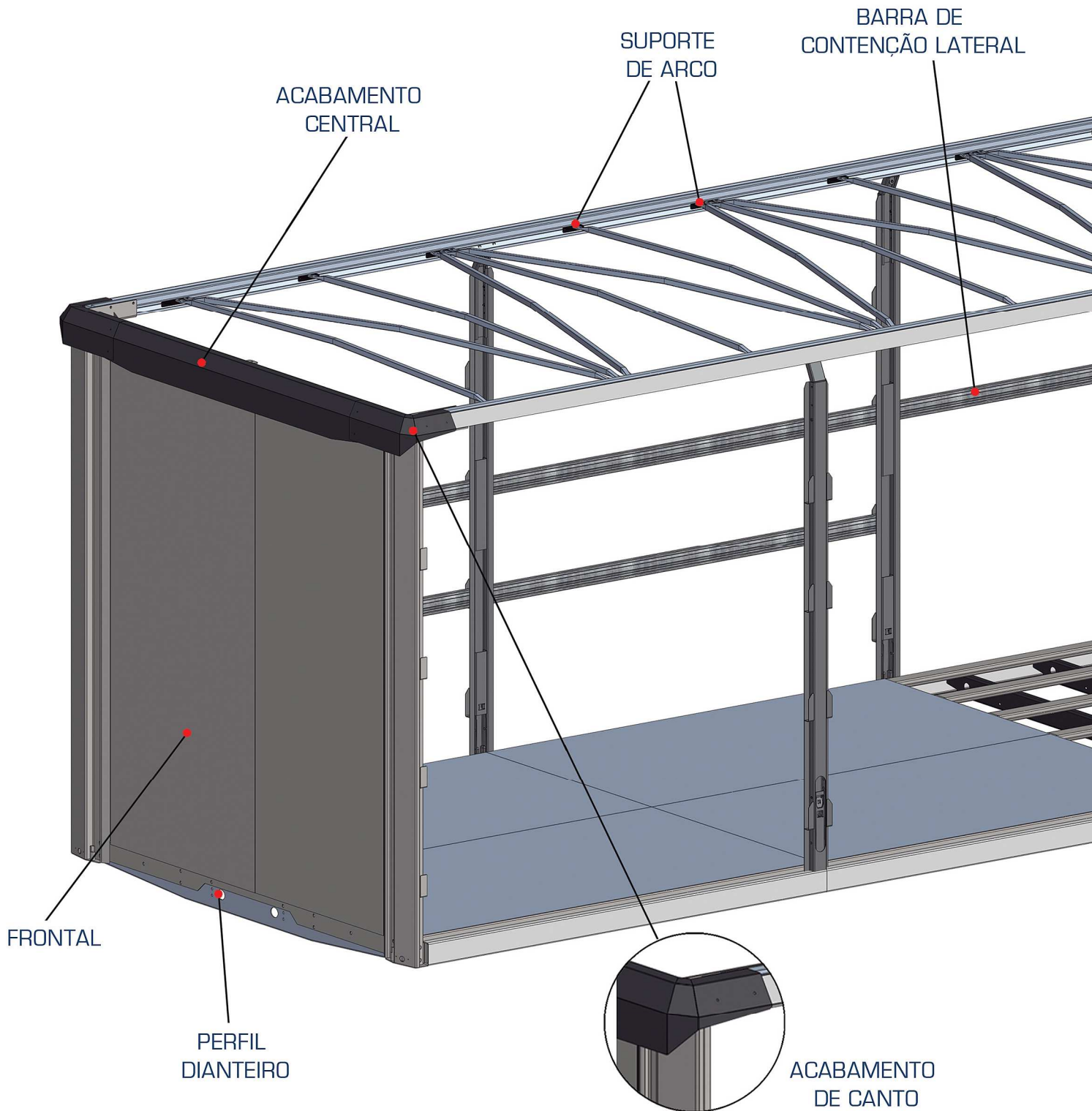

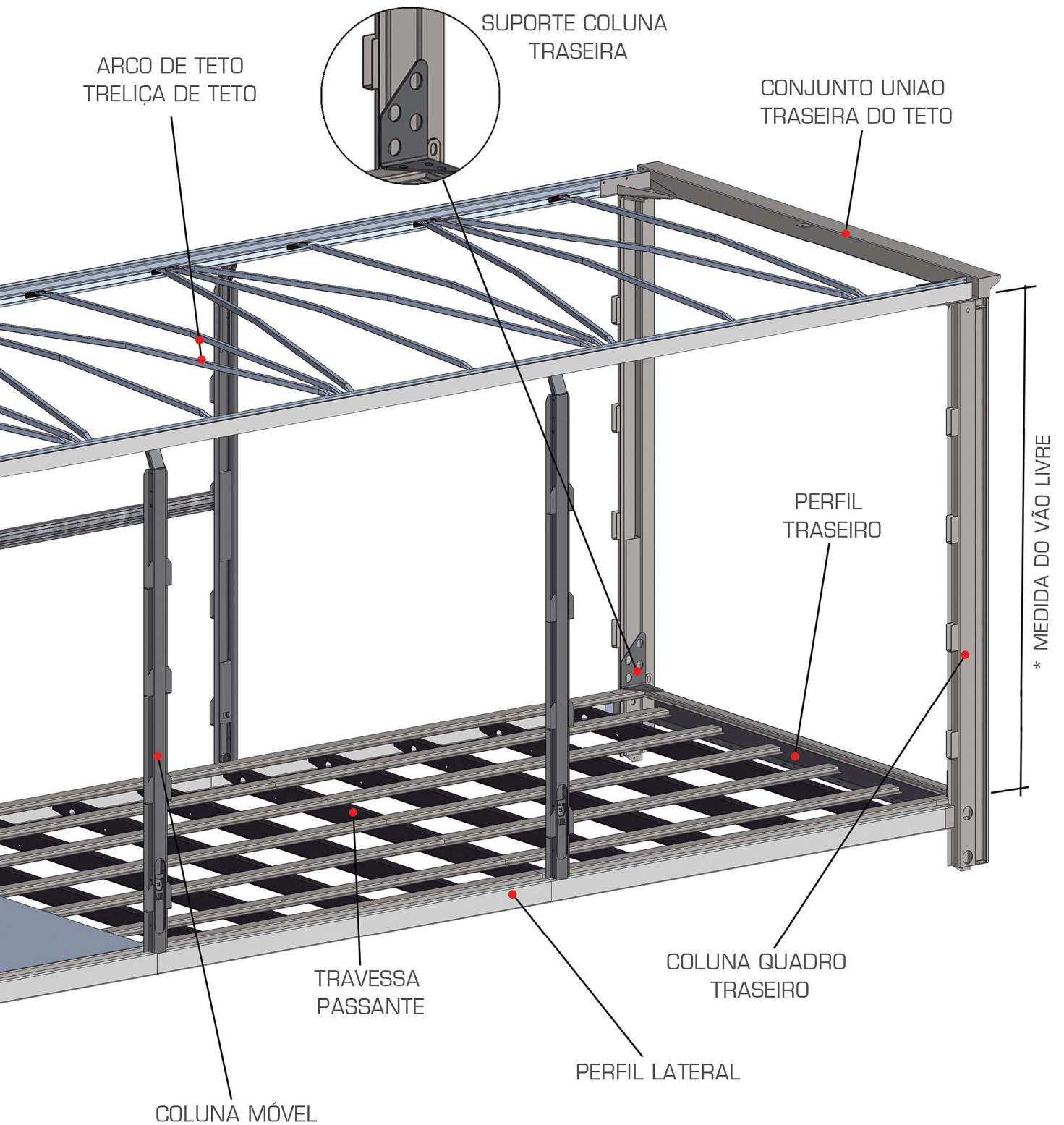

* OBSERVAR MEDIDA DO VÃO LIVRE

SDR-004

Kit Para Montagem do Frontal

COD.	MEDIDAS
SDR-004-A	2600 mm
SDR-004-B	2700 mm
SDR-004-C	2800 mm

SDR-005

Coluna Dianteira LD

COD.	MEDIDAS
SDR-005-A	2600 mm
SDR-005-B	2700 mm
SDR-005-C	2800 mm

SDR-006

Coluna Dianteira LE

COD.	MEDIDAS
SDR-006-A	2600 mm
SDR-006-B	2700 mm
SDR-006-C	2800 mm

SDR-015

Reforço Central cartola

COD.	MEDIDAS
SDR-015-A	2600 mm
SDR-015-B	2700 mm
SDR-015-C	2800 mm

SDR-016

Folha do Frontal

COD.	MEDIDAS
SDR-016-A	2600 mm
SDR-016-B	2700 mm
SDR-016-C	2800 mm

SDR-013

União Inferior Frontal

SDR-014

União Superior Frontal

* Medidas referentes ao vão livre do Sider.

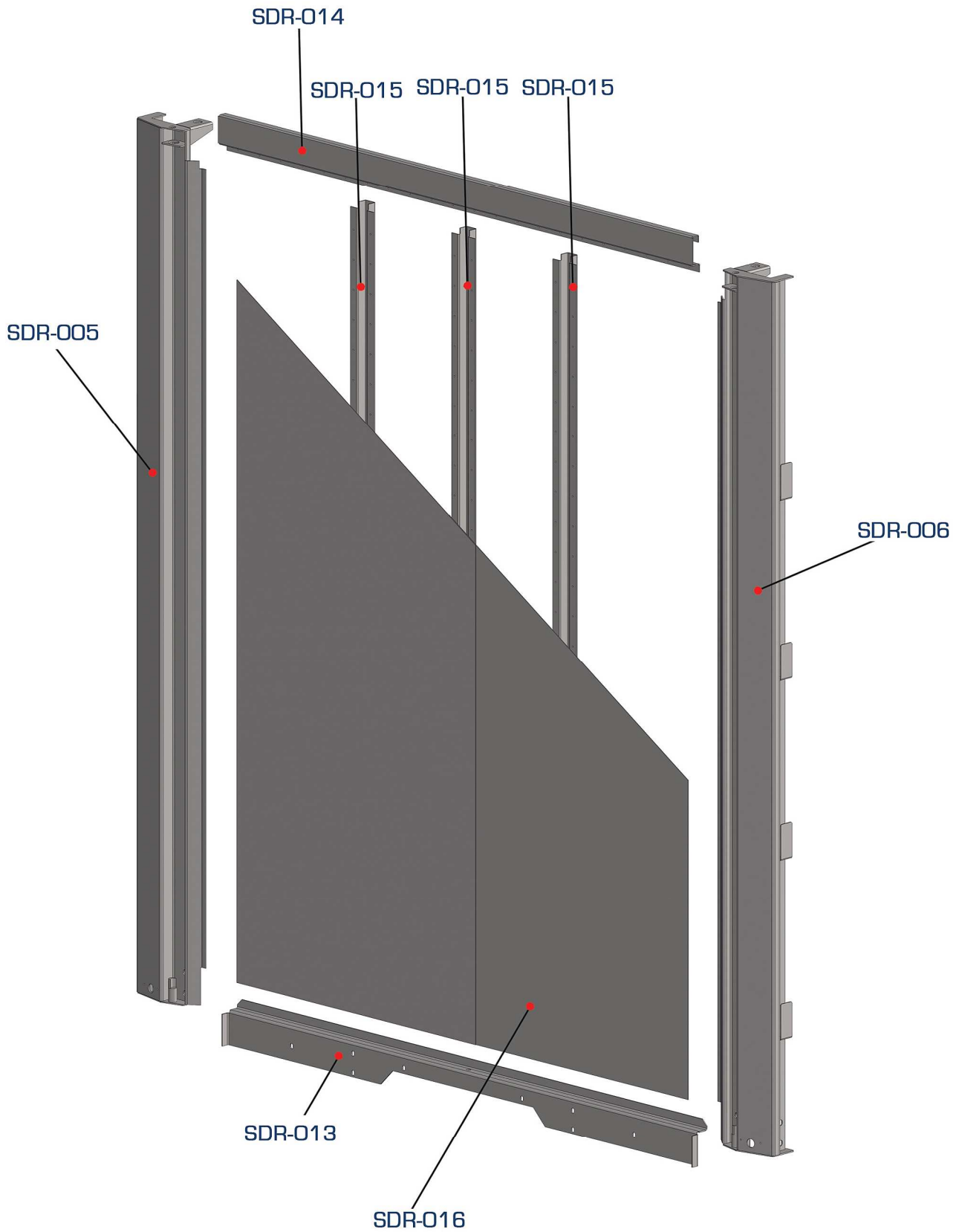



SDR-001

Conjunto Perfil Dianteira do Teto



SDR-025

Perfil Dianteiro



SDR-003-C

Acabamento Central



SDR-003-A

Acabamento de Canto LD

SDR-003-B

Acabamento de Canto LE



SDR-012

Desliza Fio
(Mod. 2018)

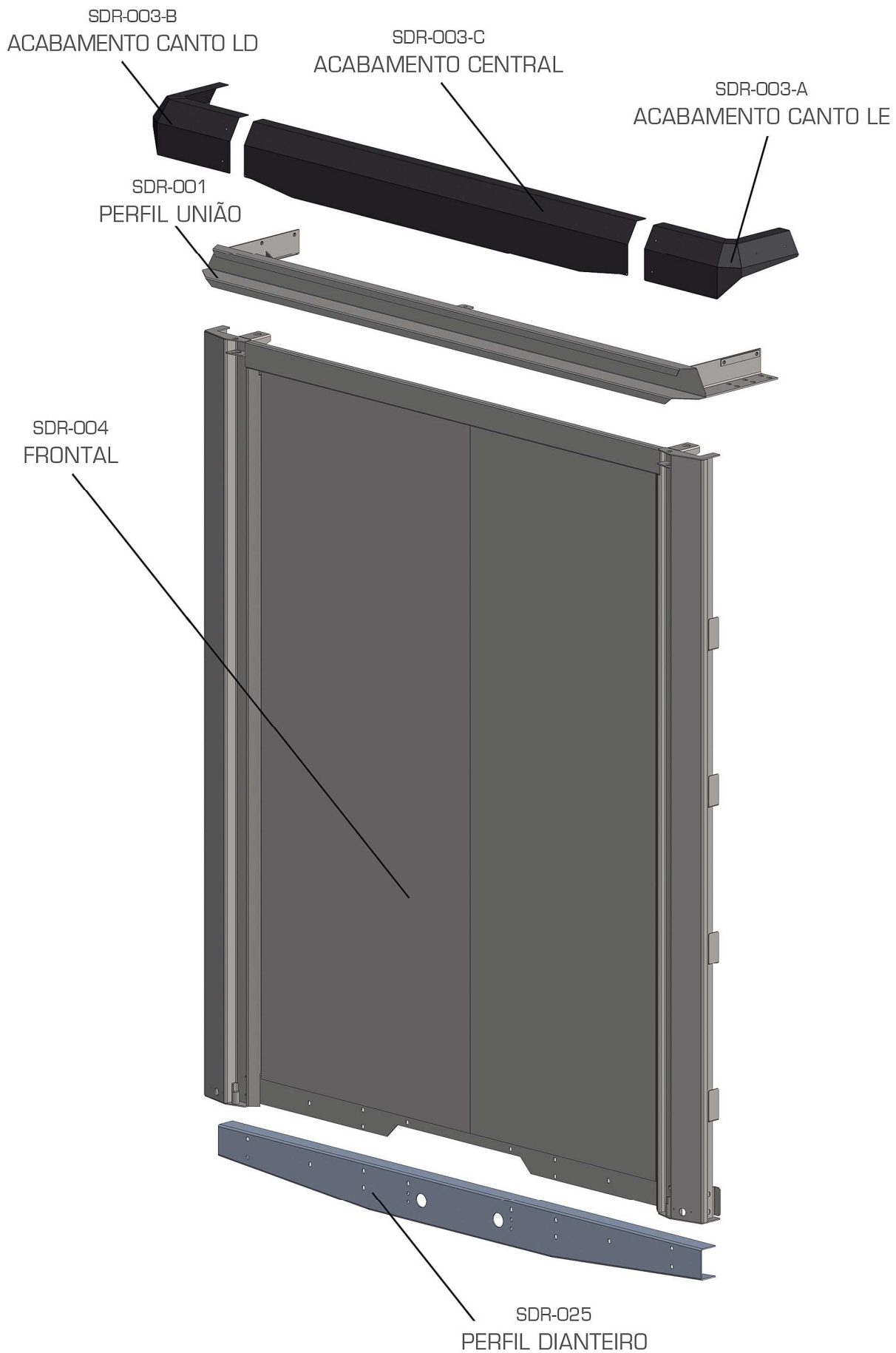

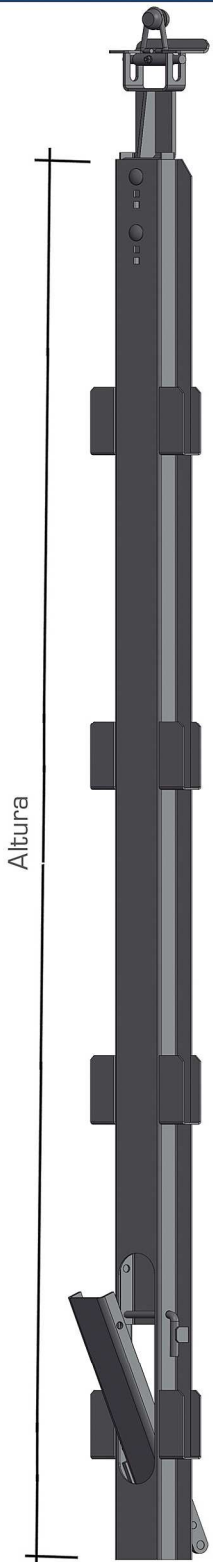

SDR-026
Travessa Passante

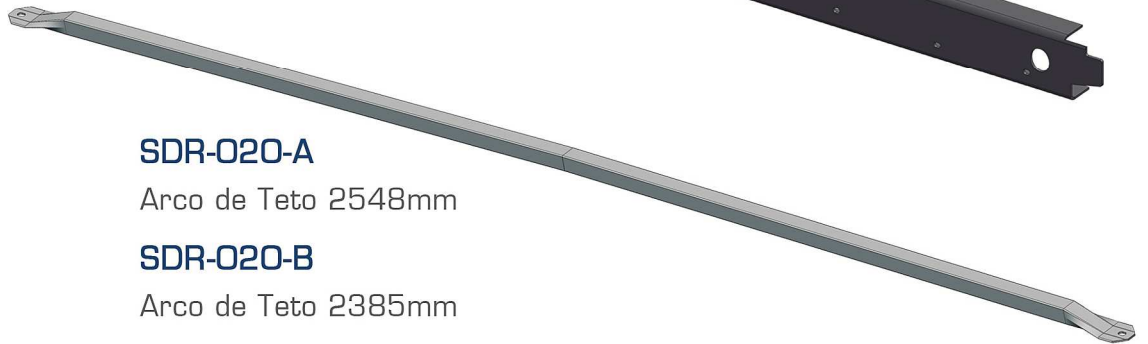

SDR-020-A
Arco de Teto 2548mm

SDR-020-B
Arco de Teto 2385mm



SD-002
Roldana da Coluna Móvel

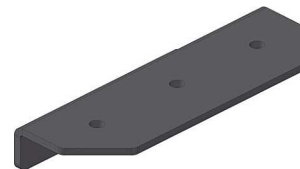

SDR-021-A
Suporte de Arco Simples

SDR-021-B
Suporte de Arco Triplo



SDF-029
Barra de Contenção



SDR-023
Perfil Lateral

SDR-010
Coluna Móvel (Alt. 2510 mm)

SDR-011
Coluna Móvel (Alt. 2660 mm)

SDR-019
Coluna Móvel (Alt. 2700 mm)
(Mod. 2018)
(acompanha roletes)



SDR-027-A
Perfil Apoio Assoalho Central

SDR-027-B
Perfil Apoio Assoalho Lateral

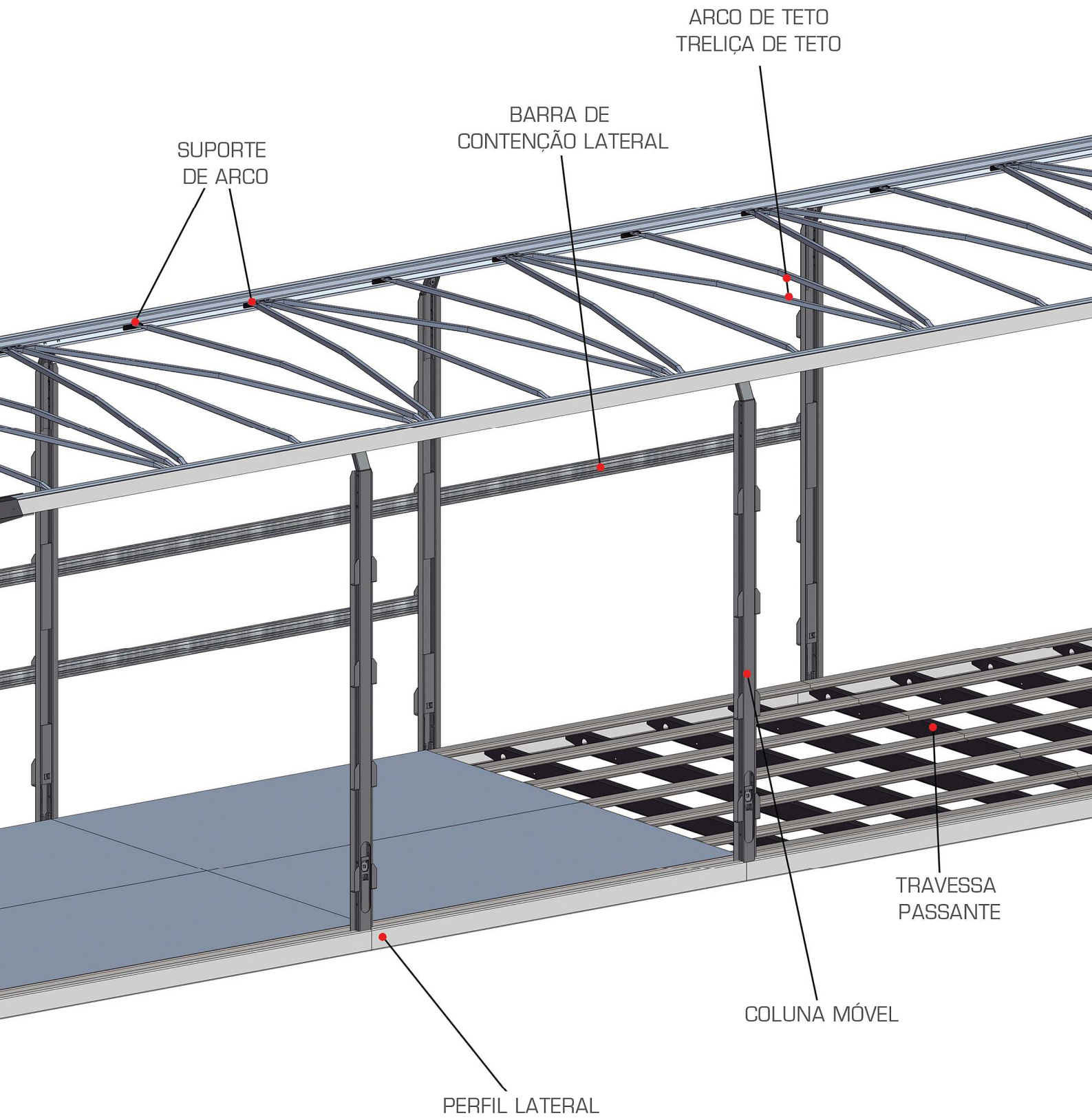

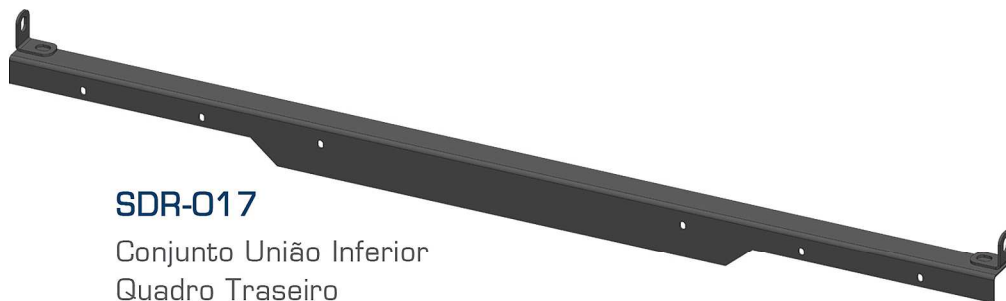

SDR-017

Conjunto União Inferior
Quadro Traseiro

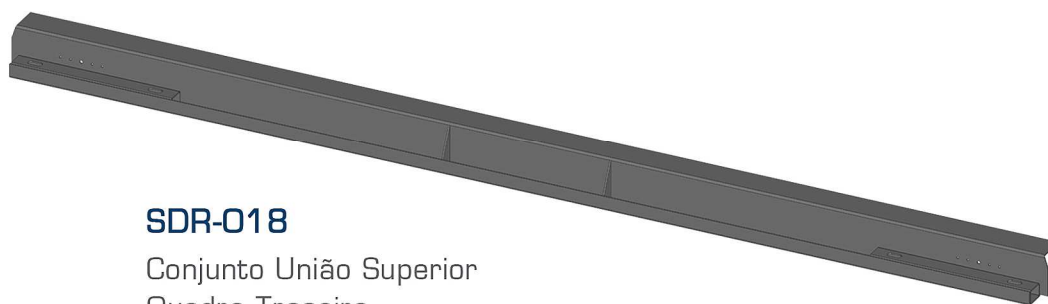

SDR-018

Conjunto União Superior
Quadro Traseiro

SDR-008

Coluna Quadro Traseiro LD

COD.	MEDIDAS
SDR-008-A	2600 mm
SDR-008-B	2700 mm
SDR-008-C	2800 mm

SDR-009

Coluna Quadro Traseiro LE

COD.	MEDIDAS
SDR-009-A	2600 mm
SDR-009-B	2700 mm
SDR-009-C	2800 mm

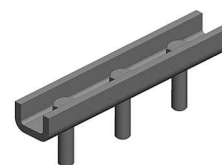

SDR-028

Fixador do Perfil

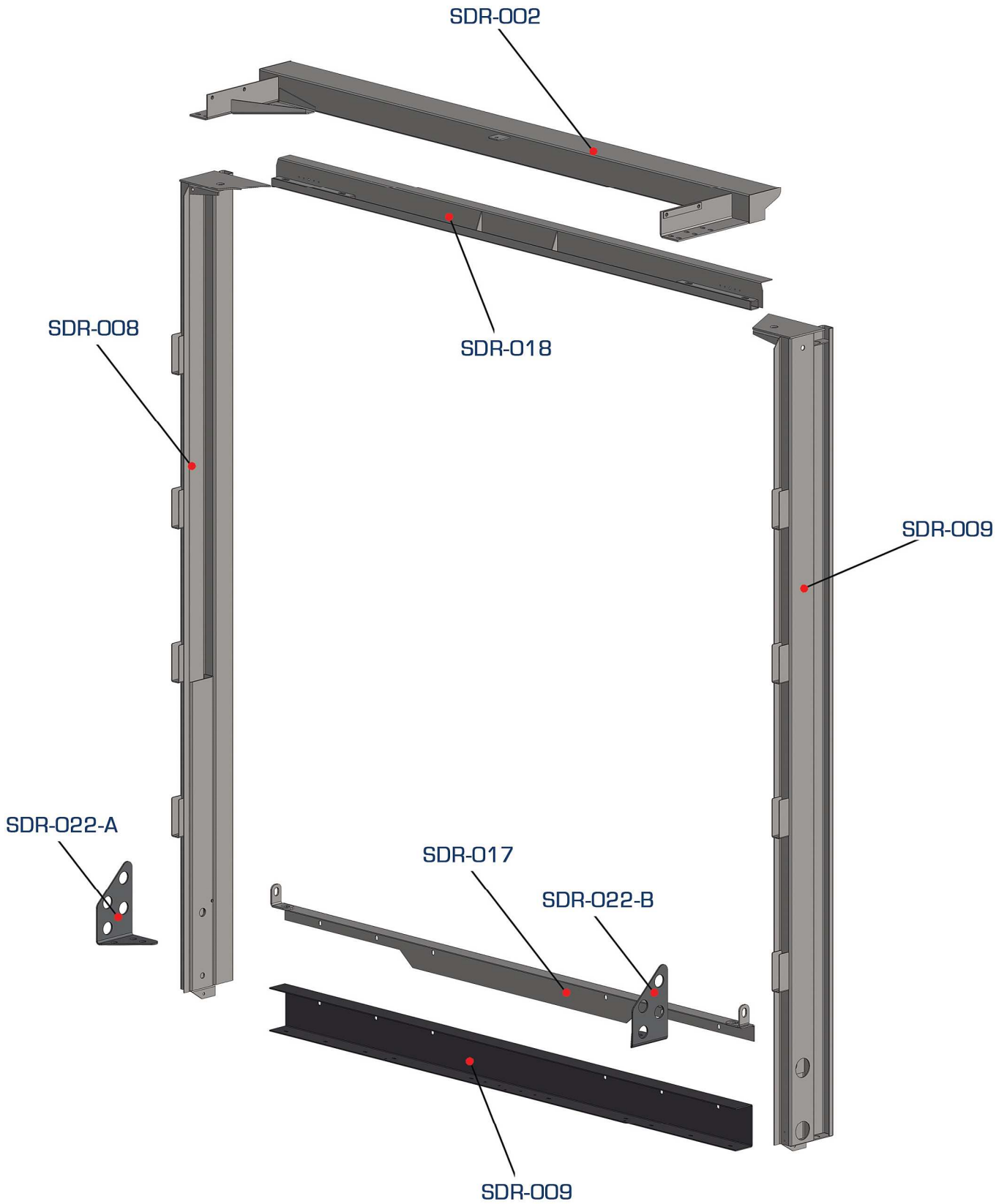



SDR-002

Conjunto Perfil Traseiro do Teto



SDR-024

Perfil Traseiro



SDR-022-A

Reforço Fixação Coluna Traseira LD

SDR-022-B

Reforço Fixação Coluna Traseira LE



SD-006
Cinta Sider Central
Lock Preto 480mm



SD-007
Cinta Sider Preto 70mm

SD-008
Cinta Sider Preto 80mm

SD-009
Cinta Sider Preto 90mm

SD-010
Cinta Sider Preto 100mm



SD-017
Cinta Sider Central
Lock Regulável



SD-016
Fivela Sider c/Fixador + Cinta 70cm



SD-011
Fivela p/Lona Sider



SD-013
Rodizio p/Lona Sider



SD-012
Fixador p/Lona Sider



SD-015
Guia Central Lock

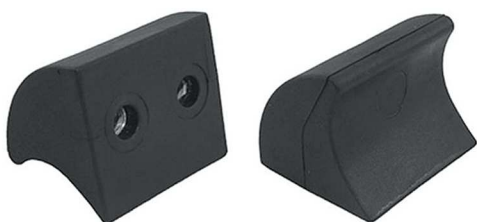

SD-001
Calço do Varão da Porta
(Sider)



SD-002
Roldana da Coluna Móvel
(Sider)



SD-003
Abraçadeira Varão Ø 33,5mm
(Sider)



SD-004
Abraçadeira Varão Ø 27mm
(Sider)



SD-005
Pega Mão (Sider/Baú)



Rua Hélio Rizzon, 121 | B. Industrial | São Marcos | RS
Cx. Postal 59 | CEP. 95190-000 | Fone (54) 3291 1803
rovali@rovali.com.br | www.rovali.com.br